



YOU CAN TRUST

THUNDER PRO SERIES

SAFETY WARNINGS AND
INSTRUCTION HANDBOOK

READ CAREFULLY BEFORE USING THIS FIREARM

BERSA S.A.

Magallanes 775 (B1704FLC), Ramos Mejía, Buenos Aires. Argentina. **TEL:** (54-11) 4003-4100 / **FAX:** (54-11) 4656-2093
info@bersa.com

INDEX

- Basic rules of firearm safety / **5**
- Model Thunder 9 PRO and Model Thunder 40 PRO.
Technical data / **6**
- Model Thunder 9 Ultra Compact PRO and
Thunder 40 Ultra Compact PRO. Technical data / **8**
- Model Thunder 45 Ultra Compact PRO.
Technical data / **10**
- Spare parts. Model Bersa PRO / **12**
- How to use your firearm / **14**
- Safety warnings / **21**

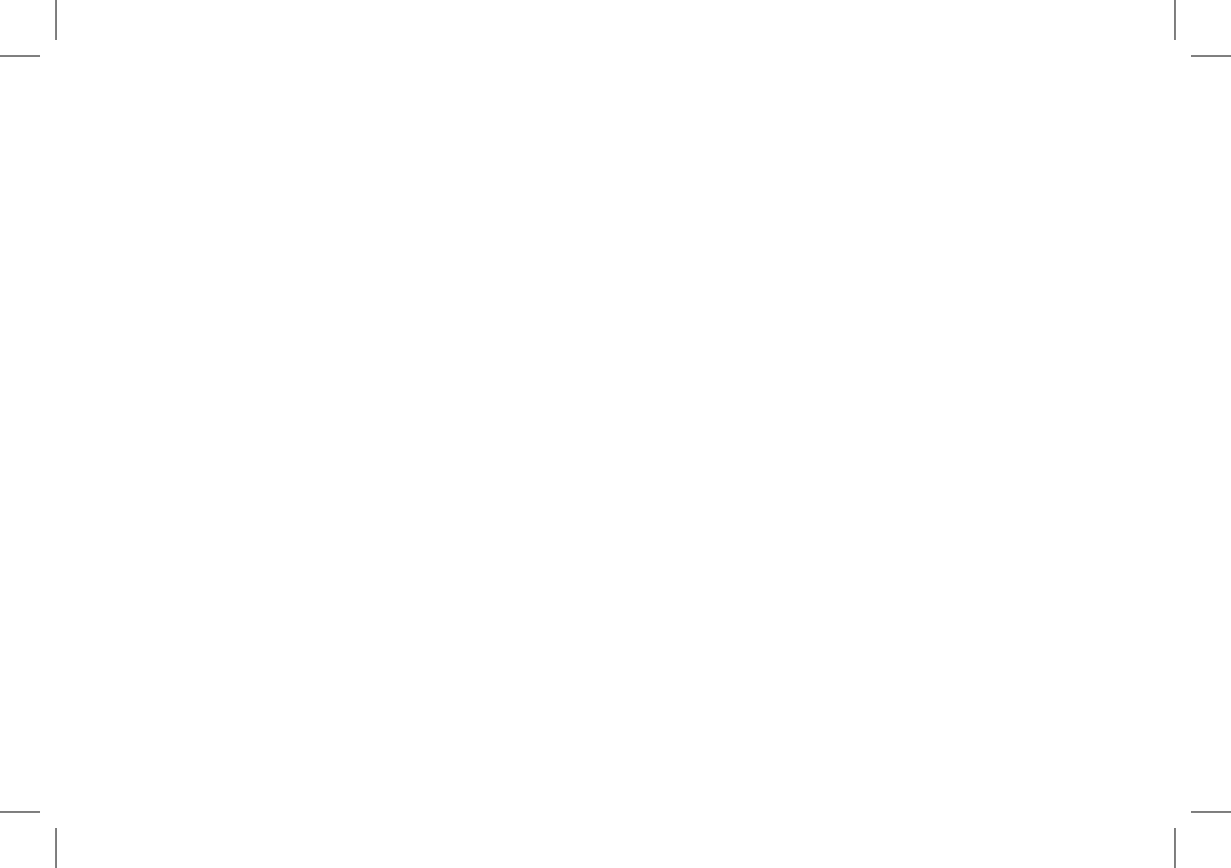

BASIC RULES OF FIREARM SAFETY.

1. Always handle every firearm as though it were loaded.
2. Always be sure the barrel is clear of any obstruction or oil.
3. Always store firearms and ammunition separately, locked if possible, and out of reach of children and others unfamiliar with firearms.
4. Always be sure of your backstop, target, what is beyond it and the safety of any bystander before shooting.
5. Always wear adequate eye and ear protection when shooting.
6. Always use clean, dry, factory-manufactured ammunition with the proper size and caliber for your firearm.
7. Never lend your firearm to anyone unfamiliar with its operation or the basic rules of firearms safety. Make sure anyone using your firearm has read and understood this Instruction and Safety Manual.
8. Never point your firearm at anything you do not intend to shoot!
9. Never carry this firearm loaded without the safety lever ON!
10. The best safety device is your own common sense. Use it.

BERSA

YOU CAN TRUST



THUNDER
9 PRO / 40 PRO

TECHNICAL DATA.

THUNDER 9 PRO

Caliber: 9 x 19 mm

Operation: Semiautomatic

Locking system: Locked Breech

Action: Single and double action

Overall length: 7.56 inches

Width: 1.46 inches

Height: 5.5 inches

Weight: 26.2 ounces

Barrel length: 4.25 inches

Rifling: R.H., 6 grooves (pitch 10 inches)

Magazine capacity: 17 + 1 cartridges

Safety features: Manual safety breaking the connection between trigger and sear / Automatic firing pin

Finish: Matte blue/duotone

Rear sight: Dovetailed to slide

Front sight: Dovetailed to slide

SPECIAL FEATURES

- Standard MIL 1913 Picatinny rail to attach accessories like lasers or flashlights
- Checkered hammer
- Checkered trigger guard
- Easy disassembly and maintenance
- Fully ambidextrous design
- Reversible magazine release
- Three white dot sights for fast target acquisition
- Decocker and safety lever
- Loaded chamber indicator

THUNDER 40 PRO

Caliber: 40 S&W

Magazine capacity: 13 + 1 Cartridges

Rifling: R.H., 6 grooves (pitch 16 inches)

BERSA

YOU CAN TRUST

THUNDER
9 Ultra Compact PRO
40 Ultra Compact PRO



TECHNICAL DATA.

THUNDER 9 Ultra Compact PRO

Caliber: 9 x 19 mm.

Operation: Semiautomatic

Locking system: Locked Breech

Action: Single and double action

Overall length: 6.53 inches

Width: 1.46 inches

Height: 4.76 inches

Weight: 23 ounces

Barrel length: 3.25 inches

Rifling: R.H., 6 grooves (pitch 10 inches)

Magazine capacity: 10 + 1 / 13 + 1

Safety features: - Manual safety breaking the connection between trigger and sear / Automatic firing pin safety / Hammer decocking safety / Internal Locking System (ILS)

Finish: Matte blue/duotone

Rear sight: Dovetailed to slide

Front sight: Dovetailed to slide

SPECIAL FEATURES

- Standard MIL 1913 Picatinny rail to attach accessories like lasers or flashlights
- Checkered hammer
- Checkered trigger guard
- Easy disassembly and maintenance
- Fully ambidextrous design
- Reversible magazine release
- Three white dot sights for fast target acquisition
- Decocker and safety lever
- Integral locking system with safety key to safe storage of the gun
- Loaded chamber indicator

THUNDER 40 Ultra Compact PRO

Caliber: 40 S&W

Magazine capacity: 10 + 1

Rifling: R.H., 6 grooves (pitch 16 inches)

BERSA

YOU CAN TRUST



THUNDER
45 Ultra Compact PRO

TECHNICAL DATA.

THUNDER 45 Ultra Compact PRO

Caliber: 45 ACP.

Operation: Semiautomatic

Locking system: Locked Breech

Action: Single and double action

Overall length: 6.81 inches

Width: 1.46 inches

Height: 5.08 inches

Weight: 27 ounces

Barrel length: 3.6 inches

Rifling: R.H., 8 grooves (pitch 16 inches)

Magazine capacity: 7 + 1

Safety features: Manual safety breaking the connection between trigger and seat / Automatic firing pin safety / Hammer decocking safety / Internal Locking System (ILS)

Finish: Matte blue/duotone

Rear sight: Dovetailed to slide

Front sight: Blade, integral with slide

Line of sight: 5.55 inches

SPECIAL FEATURES

- Standard MIL 1913 Picatinny rail to attach accessories like lasers or flashlights
- Checkered hammer
- Checkered trigger guard
- Easy disassembly and maintenance
- Fully ambidextrous design
- Reversible magazine release
- Three white dot sights for fast target acquisition
- Decocker and safety lever
- Integral locking system with safety key to safe storage of the gun.
- Loaded chamber indicator

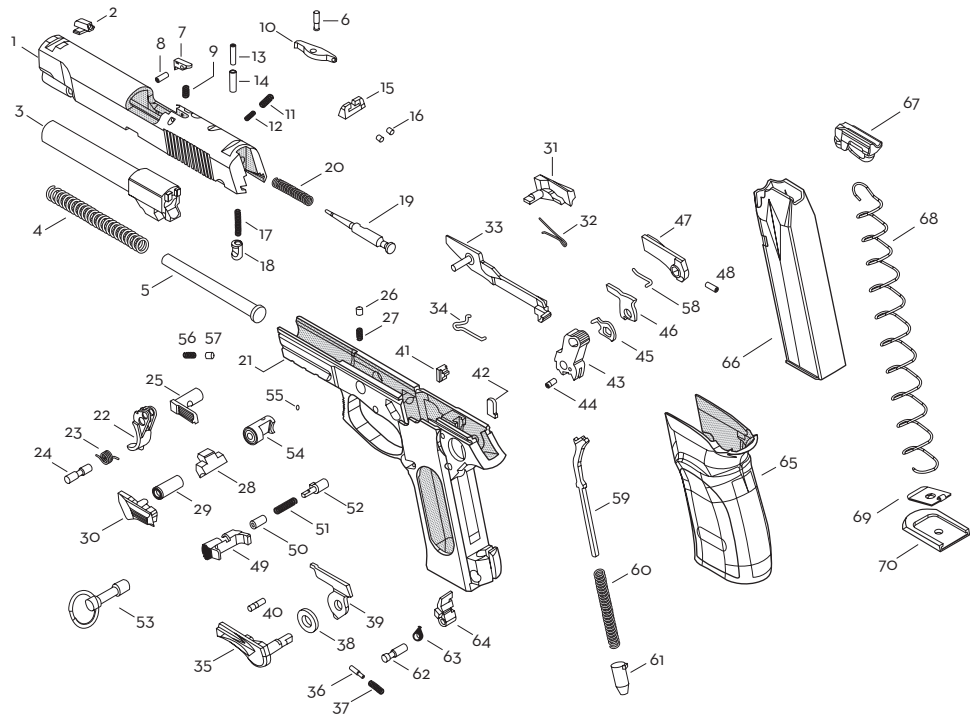

SPARE PARTS.

1. Slide
2. Front sight
3. Barrel
4. Recoil spring
5. Guide rod
6. Extractor pin
7. Loaded chamber indicator
8. Loaded chamber indicator elastic pin
9. Loaded chamber indicator spring
10. Extractor
11. External extractor spring
12. Internal extractor spring
13. Internal firing pin elastic pin
14. External firing pin elastic pin
15. Rear sight
16. Rear Sight Insert (U)
17. Automatic firing pin safety spring
18. Automatic firing pin safety
19. Firing pin
20. Firing pin spring
21. Frame
22. Trigger
23. Trigger spring
24. Trigger pin

25. Disassembly bar
26. Disassembly bar stop
27. Disassembly bar spring
28. Barrel cam
29. Barrel cam bushing
30. Slide catch (left)
31. Slide catch (right)
32. Slide catch spring
33. Drawbar
34. Drawbar Spring
35. Safety bar (left)
36. Safety pin
37. Safety spring
38. Hammer guide bush
39. Ejector
40. Safety stop pin
41. Hammer stop
42. Disconnecter
43. Hammer
44. Hammer strut pin
45. Hammer release
46. Automatic safety cam
47. Safety bar (right)
48. Safety elastic pin

49. Magazine catch
50. Magazine catch bush
51. Magazine catch spring
52. Magazine catch pin
53. Safety key *
54. Internal locking system *
55. Internal locking system bearing *
56. Internal locking system spring *
57. Internal locking system stop *
58. Safety drawbar spring
59. Hammer strut
60. Hammer spring
61. Grip catch
62. Sear pin
63. Sear spring
64. Sear
65. Grip
66. Magazine
67. Feeder platform
68. Magazine spring
69. Magazine bottom holder
70. Magazine bottom

* Only in versions with ILS

HOW TO USE YOUR FIREARM.

Remove the magazine from the pistol by depressing the magazine release button (Fig. 1).

-

LOADING THE MAGAZINE

Hold the magazine with one hand, and with the other push down the feeder platform or the round already in the magazine and carefully slide the new cartridge completely back under the lips. Repeat this procedure until the magazine is fully loaded. Damaged or bent magazine lips may cause malfunctions. Do not use force.

-

LOADING THE CARTRIDGE CHAMBER

Before loading, be sure the muzzle is pointed in a safe direction. Insert the fully loaded magazine into the pistol. Hold the firearm with one hand, and with the thumb and index fingers of the other hand grasp the serrated sides of the slide and pull it back (Fig. 2), then release the slide.

The firearm is now loaded and ready to fire.

-

LOADED CHAMBER INDICATOR

For Those pistols with loaded chamber indicator, it pivots and protrudes from the top of slide when the chamber is loaded. Check if this device works correctly when you clean your gun.

-

DO NOT DROP YOUR GUN

If it falls it may fire. If you do drop it, unload it and examine it to be sure the gun works correctly, if you have doubts, please contact a customer service center immediately

Caution: Always keep your finger off the trigger whenever you do not intend to fire.

-

SAFETY

Engage the manual safety by pushing it up (Fig. 3). This movement disengages the connection between

the trigger and the hammer.

Decock the hammer and block the slide. The red warning dot then disappears.

-

SAFETY WARNING

All owners and users of FIRESTORM pistols are reminded to use the decocking lever to decock their pistols. This is the only way to safely lower the hammer.

-

WARNING

The hammer should never be manually lowered by pulling the trigger. Manually lowering the hammer is dangerous and may result in severe personal injury or death.

WARNING: DO NOT THUMB THE HAMMER DOWN. This action may result in severe personal injury or death. ALWAYS USE THE DECOCKING LEVER.

-

FIRING

If you intend to fire your pistol, push down the manual safety lever and squeeze the trigger.

Since the hammer is uncocked, the pull on the trigger will first cock the hammer and then release it. This firing mode is called double action.

The discharge will recoil the slide which, in turn, will eject the fired cartridge case, cock the hammer, and activate the recoil spring. The slide then automatically returns forward feeding the next cartridge from the magazine into the chamber. **THE PISTOL THEN IS READY TO FIRE AGAIN.**

Squeeze the trigger to fire again.

To fire the first shot by the single action mode, simply cock the hammer manually after disengaging the safety and squeeze the trigger.

When the last round has been fired, the slide remains fully back. If you intend to fire again, remove the empty magazine and insert a loaded one. Press

the slide catch (Fig. 4) to close the slide and load the chamber.

Caution: Always keep your finger off the trigger whenever you do not intend to fire.

-

SAFETY KEY

For pistols provided with an internal locking system operated by a special key. It is located above the trigger in the left side of the frame. In the unlocked position (F) the pistol is ready to fire. In the locked position (S) you can not cock the hammer, fire in double action, load a cartridge in the chamber or disassemble the pistol. Please make sure that your pistol is in the lock position (S) when not in use.

Always store and keep your pistol unloaded and in a safe place away from minors. Replacement keys can be ordered by calling customer service at 1-732-493-0333, or on line at www.beresa.com

-

UNLOADING THE PISTOL AND CHAMBERED CARTRIDGE

Press the magazine release button and then grasp the serrated sides of the slide from the rear and draw the slide fully rearward in order to extract any car-

tridge from the barrel chamber.

When sure the chamber is empty and the cartridge has been ejected, release the slide.

-

HOW TO REVERSE THE MAGAZINE RELEASE BUTTON

After removing the magazine, push in on the grip catch slot on the bottom of the grip (page 12, part nr. 61) and turn 1/8 turn CW. Remove the grip. Repeat the same procedure, turning 3/8 turn CCW the pin of the magazine release button (page 12, parts nr. 49-52) until it is dropped out. Put the magazine release button in the place of your preference following the above procedure in reverse order. Replace the grip and push-turn the slot of the grip catch 1/8 turn CCW. Slot should be across the pistol from side to side. Release pressure on the grip catch and allow it to return to its former position.

Warning: Failure to follow this procedure may result in an unsecured main spring.-

MAINTENANCE.

It is recommended to clean and lubricate the pistol every time it is fired.

-

FIELD STRIPPING

Make sure the pistol is unloaded.

Depress the magazine release button and remove the magazine. With right thumb rotate disassembling latch until it stops (Fig. 7). Pull forward the slide-barrel assembly with recoil spring and spring guide (Fig. 8). Slightly pressing the recoil spring guide head, lift the recoil spring guide (Fig. 9 and 10). Take out the barrel from the slide.

No further disassembly is recommended unless done by a competent gunsmith.

-

CLEANING AND LUBRICATING

After dismantling, clean the barrel and chamber with a light film of high quality gun oil to clean all exposed internal surfaces. Put special attention on

the bolt face (where the firing pin protrudes) and under the extractor hook. Lubricate moving parts sparingly with a light high quality gun oil. Wipe off any excess oil.

-

ASSEMBLY

Assemble following the Field Stripping procedure in reverse order. It is advisable to pay attention to the following points:

The recoil spring guide head should lodge in the center of its groove in the barrel base.

When rotating the disassembling latch, the slide should be in the closed position.

REFERENCES

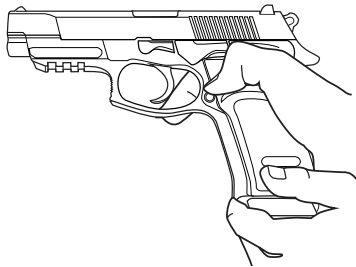

Fig. 1

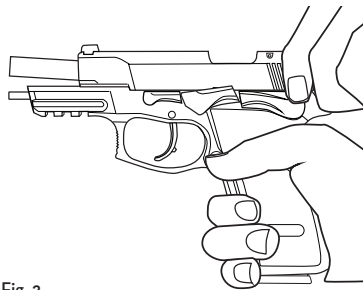

Fig. 2

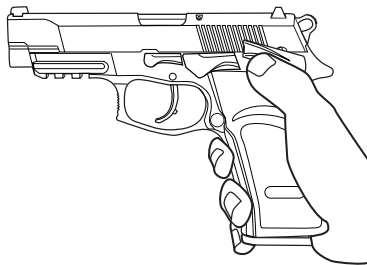

Fig. 3

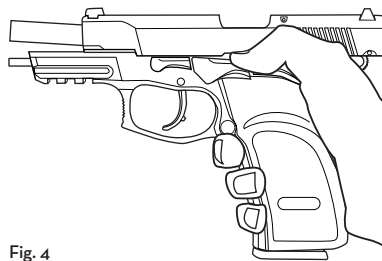

Fig. 4

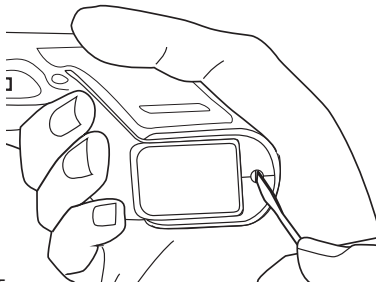

Fig. 5

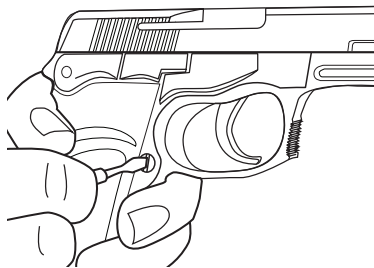

Fig. 6

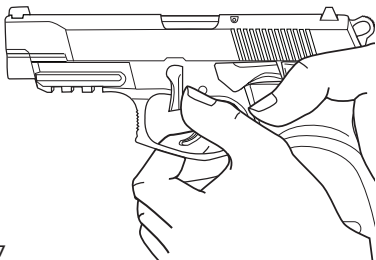

Fig. 7

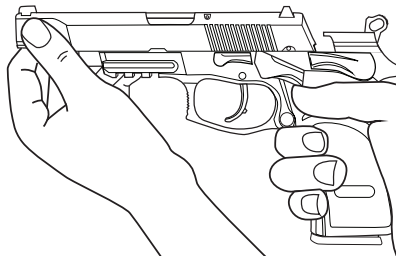

Fig. 8

REFERENCES

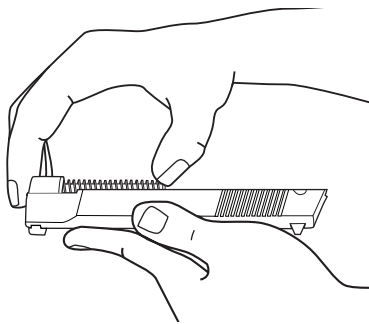

Fig. 9

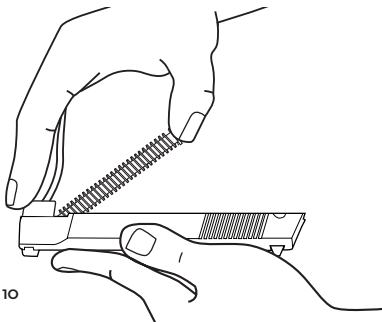

Fig. 10

SAFETY WARNINGS.

EAR AND EYE PROTECTION

Use ear plugs or earmuff-type protectors to guard you against cumulative, permanent hearing loss as a result of continuous exposure to shooting noise. Shooting glasses will guard you against powder, gas, carbon residue, lubricant, metallic particles or similar debris that may emanate occasionally from any firearm in normal use. Always make sure that anyone near you is also wearing ear and eye protection.

-

SAFETY MECHANISM

1. Your firearm has an effective, well-designed safety mechanism. However, there's no safety mechanism capable of substituting your common sense and good safety procedures. No safety can guard you against horseplay, carelessness, or improper use. It may become ineffective by breakage or malfunction due to abusive use, incorrect assembly, or unauthorized adjustments.

2. While handling any firearm, never allow it to point at any part of your body or at another person. No harm should result if you obey this rule, even if an accidental discharge occurs.

3. The safety mechanism should be on until you are actually aiming at the target ready to shoot.
4. When turning the safety ON or OFF, point the muzzle in a safe direction and keep your finger off the trigger.
5. Be sure to put the safety in the correct position or it will not be effective. Some firearms have a red warning dot next to the safety which should be totally covered when the safety is on.
6. Do not carry the firearm loaded without the safety on (Double action revolvers and some double action pistols have an automatic internal safety mechanism instead of a manual one).

-

LOADING

1. Be sure the muzzle is pointing in a safe direction when

loading the firearm.

2. Do not load or unload a firearm in a confined space such as a vehicle or building other than a well-constructed shooting range. In an enclosed area there is not usually a safe direction in which to point the firearm, and if accidentally fired, there is a great risk of causing personal injury or property damage.
3. Clean all oil and grease from the chamber before loading, and be sure nothing is obstructing the barrel. Any obstruction in the barrel may cause the barrel to bulge or burst when firing, or otherwise damage the firearm or injure the shooter and bystanders.

FIRING

1. When cocking a firearm, keep your finger off the trigger and point the muzzle in a safe direction.
2. Never carry a cocked firearm around or leave it unattended! A cocked firearm will fire with the slightest pressure on the trigger. If you fall or the firearm is dropped, or someone hits it, an accidental firing may occur.
3. When firing a semi-automatic gun, keep your fingers, hand, face and all other parts of your body away from

the ejection port, or any other part of the slide (or bolt) when it is moving. The shooter will not be injured if the firearm is held and fired at arm's length.

4. Be sure no one is standing where they may be struck by an empty cartridge case. Ejected cases are hot and may cause burns, cuts or eye injuries (if no eye protection is worn). Be sure there is a clear, safe, unobstructed path for fire cases to be ejected. And also be sure they will not bounce off a hard object and hit someone.
5. If your firearm has a mechanical malfunction while shooting, or if powder or gas emanates from it, or if a cartridge case is bulged or ruptured, or if the sound of the fire is not quite right, DO NOT CONTINUE SHOOTING. STOP IMMEDIATELY AND UNLOAD THE FIREARM. Then take the firearm and ammunition to your gunsmith.
6. A loaded cartridge case that becomes jammed in a semiautomatic gun between the slide (or bolt) and the barrel may be removed as follows: Keep the muzzle pointed in a safe direction. First, remove the magazine, and then pull the slide or bolt back. Hold it or lock it to the rear. Remove the jammed case by

shaking the firearm or pick it out with your fingers.

-

UNLOADING

1. Be sure the muzzle is pointed in a safe direction.
2. After removing the magazine, be sure to clear the chamber.
3. Do not assume a firearm is unloaded until you have visually checked it.

-

TRANSPORTING AND STORING YOUR FIREARM

1. Always keep your firearm unloaded when transporting it to and from shooting activities.
2. Store firearms and ammunition separately, preferably locked and secured. Keep firearms and ammunition out of reach of children, untrained individuals or careless, unauthorized adults.

-

SEMI-AUTOMATIC PISTOLS

1. Carrying a semi-automatic pistol with a cartridge in the chamber greatly increases the chances of accidental firing. Doing so may only be justified in cases of clear and present danger. For instance, in cases of self-defense you may have to fire your pistol instantly,

however this is not recommended. The safest way to carry a loaded pistol is to have the chamber empty.

2. If you MUST carry a semi-automatic pistol with a cartridge in the chamber, be sure the hammer is decocked. If your pistol has a hammer lowering lever, use this lever instead of the trigger to lower the hammer. And also, if your pistol has a manual safety, always leave it on when carrying the pistol with a cartridge in the chamber until the firearm is aimed at the target ready to shoot.

-

AMMUNITION

1. Use high-quality, original, factory-manufactured ammunition in your firearm. Never use ammunition that is wet, dirty, corroded or damaged. Never oil or lubricate ammunition or let excess aerosol lubricants, preservatives, or cleaners come into contact with cartridges. This may cause dangerous malfunction problems. Be sure your ammunition has the proper caliber, which is engraved on the firearm. Do not use ammunition of any other caliber.
2. Reloading ammunition is a science. Improperly loaded ammunition may cause severe damage to

your firearm and severe injury to both the shooter and other individuals. Use ammunition approved by the U.S. Sporting Arms and Ammunition Manufacturers Institute, Inc. (SAAMI). All warranties are void if you use reloaded, remanufactured, handloaded, or other non-standard ammunition.

3. Excessive pressure inside the chamber or the barrel may cause severe damage to the firearm and/or severe injury to the shooter. This may be caused by obstructions in the barrel, propellant powder overloads, or the use of incorrect, wrongly assembled, dirty, corroded or damaged cartridges.
4. Stop shooting IMMEDIATELY and check the barrel for obstructions if:
 - you have difficulties in chambering a cartridge or feel unusual resistance
 - a cartridge misfires
 - a fired cartridge case is not extracted
 - you see unburned grains of powder in the mechanism
 - a shot sounds abnormal or weak.

These obstructions may be caused by a bullet lodged way down the barrel. Do not fire another bullet in the obstructed barrel as this may damage the fier-

arm and cause serious injury to both the shooter and bystanders.

5. Wipe any oil preservative from the chamber before shooting and do not lubricate the cartridges. Lubricants interfere with the required friction between the cartridge case and the chamber wall. This causes stress similar to excessive pressure.
6. Do not use too much lubricant on your guns moving parts. Do not spray gun care aerosol products where they may come into contact with ammunition. Do not overspray. Lubricants, specially aerosol sprays, may penetrate cartridge primers and cause the ammunition to misfire. Some lubricants may get inside cartridge cases and prevent powder from igniting. If only the primer ignites, the bullet may become lodged in the barrel.

FIREARM CARE

1. When your firearm is delivered it comes in a factory package and has a light coating of protective grease and oil. Clear all this grease and oil from the bore and exposed mechanism before loading.
2. Double-check your firearm is unloaded before dis-

assembling it for cleaning.

3. After cleaning, make sure you have not left a cleaning patch or any other obstruction in the bore or chamber.

PARTS

BERSA's distributor has a complete supply of replacement parts. Even though most gunsmiths are highly qualified to make the necessary repairs to your firearm, the workmanship of any particular gunsmith, other than those in our Service Department, is totally beyond our control. Should your firearm ever require service, we strongly recommend that you return it to an Authorized Warranty Center. Unauthorized adjustments or parts replacement can void your warranty.

It is the responsibility of the purchaser to be absolutely certain that any parts ordered from **BERSA®** are of the correct type and are properly fitted and installed by a competent person. **THE IMPROPER FITTING OF PARTS OR IMPROPER MECHANICAL ADJUSTMENT MAY RESULT IN A DANGEROUS MALFUNCTION, DAMAGE TO THE FIREARM, AND POSSIBLE SEVERE INJURY TO THE SHOOTER OR TO**

OTHERS. Therefore, the purchaser and/or installer of parts must accept full responsibility for the correct adjustment and function of the firearm after such installation has been made or attempted.

SERVICE POLICY

Your firearm has been carefully inspected and tested before being shipped to ensure it meets our specifications and standards. If your firearm needs adjustments, refinishing or repairs, we highly recommend that you obtain factory service from an Authorized Warranty Center. If you have any questions about your firearm's performance, write, call or email to our Service Department and accurately describe the situation.

RETURNING FIREARMS FOR SERVICE

1. Federal Licensed dealers may ship handguns via U.S. Mail. The Post Office confiscates hand guns mailed by private individuals.
2. Under Federal Law, you may return rifles by U.S. Mail. Other firearms may be returned by common carriers such as United Parcel Services (UPS). State and local gun laws vary greatly. Consult your local prosecuting

attorney about any laws in your area that may restrict shipping or receiving firearms. Taking all these facts into account, we strongly recommend that you send your firearm for repairs to our Authorized Warranty Center through a Federal Licensed dealer.

3. All firearms must be sent out by prepaid shipment. WE DO NOT ACCEPT COLLECT SHIPMENTS.
4. Together with the firearm, enclose a letter indicating the serial number, caliber and barrel length, and also the work that is needed or the problem you have experienced with the firearm. Be specific. Do not simply write the words “defective” or “repairs needed”. In addition, enclose copies of any previous letters dealing with the repairs. There will be a minimum service charge for repair works that are not covered by the warranty.
5. YOUR FIREARM MUST BE SHIPPED UNLOADED. Before shipping, double-check the chamber to make sure it is unloaded. By law, **BERSA**'s distributor is required to notify Federal authorities if firearms are sent loaded.
6. When shipping firearms to an Authorized Warranty Center, do not include custom grips or stocks, belts,

slings, holsters, telescopic sights, or any other accessory.

-

LIABILITY

REVOLVERS AND PISTOLS ARE CLASSIFIED AS FIREARMS OR DANGEROUS WEAPONS. **BERSA**® and its Distributors sell them pursuant to the specific understanding that they are not responsible, in any way whatsoever, for the safe handling or resale of the firearm under local laws and regulations.

BERSA® and its Distributors do not assume responsibility for any firearm malfunction, personal injury, or property damage resulting in whole or in part from criminal or negligent discharge, improper or careless handling, unauthorized modifications, use defective, improper, reloaded, or handloaded ammunition, customer neglect, corrosion, any other circumstances or effects beyond their direct and immediate control.

This limitation is applicable regardless of whether the liability is asserted on the basis of negligence, contract, or strict liability (including any failure to give a warning).

BERSA and its Distributors are not liable under any circumstances for any incidental or consequential damages such as commercial loss, loss for use of property, and/or loss of profits or earnings.

IMPORTANT: Keep this manual with your firearm! the manual must be transferred with change of ownership.

Serial number: _____

Owner: _____ Purchase date: _____

Owner: _____ Purchase date: _____

Owner: _____ Purchase date: _____

Note: This information can be of great value to you for insurance purposes. Please, keep this manual in a secure place.

LIMITED WARRANTY

BERSA S.A., Magallanes 775, - B1704 FLC Ramos Mejía, Argentina, Warrants to the original purchaser that this **BERSA®** firearm will be free from defects in material and workmanship under normal use for a period of one year from the date of purchase. Under this warranty, **BERSA S.A.** shall repair or replace any defective part, or at our option, exchange the firearm within a reasonable time and without charge. Claim under this warranty should be submitted in writing the state one year period, together with proof of the date of purchase and the firearm (insurance and shipment prepaid by the purchase) to an authorized warranty center indentified on the enclosed list. Return shipment and insurance shall be paid by **BERSA®** provided the claim is covered by this warranty.

This warranty shall be waived if the claimed defect or malfunction was caused by neglect, abuse, careless handling, unauthorized adjustment, alterations

or modifications, improper ammunition, or unreasonable use.

BERSA S.A. SHALL NOT BE RESPONSIBLE FOR ANY INCIDENTAL OR CONSEQUENTIAL DAMAGE FOR BODILY INJURY PROPERTY DAMAGE OR ECONOMIC LOSS UNDER THIS WARRANTY OR OTHER GROUNDS. SOME STATES DO NOT ALLOW THE EXCLUSION OR LIMITATION OR EXCLUSION MAY NOT APPLY TO YOU

This warranty gives you specific legal rights, and you may also have other rights wich vary from state to state. If you requiere assistance in connetion with this warranty, contact:

EAGLE IMPORTS, Inc
1750 Brielle Ave. UNIT B-1.
Wanamassa,NJ07712.
www.bera.com
www.eagleimportsinc.com

LIFE TIME SERVICE CONTRACT

Please visit our website for Current Warranty center locations. Do not send pistols to our New Jersey location.

Upon the expiration of the one-year Warranty, and for as long as this **BERSA®** firearm is owned by the original purchaser, **BERSA S.A.** offers to service and repair any defects or malfunction in this **BERSA®** firearm, excluding the finish, grips, sight or magazine, without charge. Requests for service should be submitted in writing, together with proof of purchase and the firearm (insurance and shipment prepaid by the purchaser), to an authorized service center identified on the enclosed list. Return shipment and insurance shall be paid by **BERSA®** provided the service is covered by this service contract.

This service contract is extended only to the original purchaser, is not transferable, and shall be waived if the defect or malfunction was caused by neglect, abuse careless handling, willful damage, damage caused by overpressure ammunition, or unauthorized ammunition, ordinary wear and tear, unreasonable use, or failure to provide reasonable and

necessary maintenance as set forth in the instruction manual. Moreover, this agreement will not apply to those parts of you **BERSA**® firearm which have been “tuned” or “gunsmithed” for performance other than customized tuning and other services provided by an authorized service center.

Please complete and return the enclosed original purchaser registration card, found in your firearm’s box, to assist us in providing this service to you. If you require assistance in connection with this service contract, please contact:

EAGLE IMPORTS, Inc

1750 Brielle Ave., Unit B-1 Wanamassa, NJ 07712

732 - 493 - 0333

www.beresa.com

info@beresa.com

www.eagleimportsinc.com

Do not send guns to the NJ office.

NOTICE: It is illegal to, among other things, ship firearms with ammunition in the firearm or in the same packaging. Firearm and ammunition must be shipped separately. Make sure you are in compliance with all local and federal laws when shipping a firearm for repair under this service contract to any authorized service center. You are solely responsible for understanding and complying with all state, federal, or other applicable laws or regulations regarding the shipment of firearms and/or ammunition.

THE USE OF A LOCKING DEVICE OR SAFETY LOCK IS ONLY ONE ASPECT OF RESPONSIBLE FIREARM STORAGE. FIREARM SHOULD BE STORED UNLOADED AND LOCKED IN A LOCATION THAT IS BOTH SEPARATE FROM THEIR AMMUNITION AND INACCESSIBLE TO CHILDREN AND OTHER UNAUTHORIZED PERSONS.

WARNING

Children are attracted and can operate firearms that can cause severe injuries or death.

Prevent child access by always keeping guns locked away and unloaded when not in use. If you keep a loaded firearm where a child obtains and improperly uses it, you may be fined or sent to prison.

ATENCIÓN

A los niños les atrae las armas de fuego y pueden manipularlas pudiendo causarles heridas graves o la muerte.

Impida el acceso de los niños manteniendo las armas guardadas con llave y descargadas cuando no estén en uso. Si usted mantiene un arma de fuego cargada al alcance de un niño o la usa inapropiadamente, puede ser multado o enviado a prisión.

EXHIBIT F-2

DISCHARGING FIREARMS IN POORLY VENTILATED AREAS, CLEANING FIREARMS, OR HANDING AMMUNITION MAY RESULT IN EXPOSURE TO LEAD AND OTHER SUBSTANCE KNOWN TO THE STATE OF CALIFORNIA TO CAUSE BIRTH DEFECTS, REPRODUCTIVE HARM, AND OTHER SERIOUS PHYSICAL INJURY. HAVE ADEQUATE VENTILATION AT ALL TIMES. WASH HANDS THOROUGHLY AFTER EXPOSURE.

WARNING FROM THE MASSACHUSETTS ATTORNEY GENERAL

This handgun is not equipped with a device that fully blocks use by unauthorized user. More than 200,000 firearms like this one are stolen from their owners every year in the United States. In addition, there are more than a thousand suicides each year by younger children and teenagers who get access to firearms.

Hundreds more die from accidental discharge. It is likely that many more children sustain serious wounds, or inflict such wounds accidentally on another. In order to limit the chance of such misuse, it is imperative that you keep this weapon locked in a secure place and take other steps necessary to limit the possibility of theft or accident. Failure to take reasonable preventive steps may result in innocent lives being lost, and in some circumstances may result in your liability for these deaths.

