



***CRIMSON TRACE***®

**USER GUIDE**

RIFLESCOPE SETUP

# PLEASE READ THE ENTIRE MANUAL

**FAILURE TO FOLLOW THESE INSTRUCTIONS AND PROCEDURES MAY RESULT IN INJURY OR DEATH.**

Always follow firearm safety rules as outlined by the firearms manufacturer.

Keep this and all firearm related products locked and secured from children or other unauthorized users.

---

## CONTENTS

KEY FEATURES .....	4
MAINTENANCE AND TROUBLESHOOTING.....	5
MOUNTING YOUR NEW RIFLESCOPE .....	6
ZEROING YOUR NEW RIFLESCOPE.....	8
COMMON CHALLENGES .....	10
WARRANTY.....	10

## GENERAL WARNINGS

 WARNING: READ THESE INSTRUCTIONS AND WARNINGS CAREFULLY. BE SURE YOU UNDERSTAND THESE INSTRUCTIONS AND WARNINGS BEFORE USING THIS PRODUCT ON A FIREARM. FAILURE TO READ THESE INSTRUCTIONS AND TO FOLLOW THESE WARNINGS MAY RESULT IN SERIOUS INJURY OR DEATH TO YOU AND OTHERS AND DAMAGE TO PROPERTY.

 WARNING: ENSURE THAT YOUR FIREARM IS UNLOADED, THE MAGAZINE IS REMOVED, THE SAFETY IS ON AND YOUR FINGER(S) ARE OFF THE TRIGGER BEFORE ATTEMPTING TO INSTALL, REMOVE OR ADJUST YOUR SCOPE. FOLLOW THE BASIC FIREARMS SAFETY RULES AT ALL TIMES.

 WARNING: DO NOT INSTALL OR USE THIS PRODUCT IF THE INSTALLATION OF THE PRODUCT IN ANY WAY AFFECTS THE SAFE FUNCTION OF THE FIREARM. IF, WHILE INSTALLING THIS PRODUCT, YOU HAVE ANY TROUBLE WITH THE FIT OR FUNCTIONALITY OF THE FIREARM, STOP IMMEDIATELY AND CALL CUSTOMER SERVICE FOR ASSISTANCE AT 800-442-2406.

 WARNING: FAILURE TO SECURELY MOUNT YOUR SCOPE CAN RESULT IN SERIOUS INJURY.

 WARNING: DO NOT LOOK AT THE SUN THROUGH THE RIFLESCOPE. IT WILL PERMANENTLY DAMAGE YOUR EYE.

 **WARNING: Cancer and Reproductive Harm - [www.P65Warnings.ca.gov](http://www.P65Warnings.ca.gov)**

## KEY FEATURES

- A. TURRET CAPS
- B. OBJECTIVE LENS
- C. ELEVATION TURRET
- D. WINDAGE TURRET
- E. MAGNIFICATION SELECTOR RING
- F. OCULAR LENS
- G. RETICLE FOCUS / DIOPTER ADJUSTMENT
- H. BODY TUBE

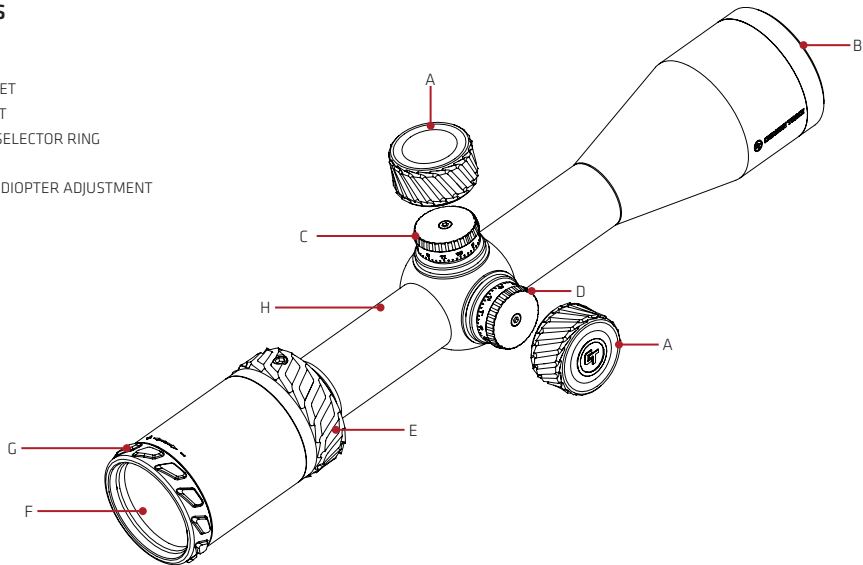

## MAINTENANCE AND TROUBLESHOOTING

Your Crimson Trace Riflescope requires very little maintenance. It is internally lubricated from the factory and nitrogen purged for a lifetime of service. Depending on use, external optics may require periodic cleaning. Crimson Trace recommends using the included cleaning cloth. Other optic specific cleaning cloths or lens pens may also be used. **WARNING: always blow dirt and debris from the optics prior to wiping.** If significant cleaning is required, water or isopropyl alcohol may be used in conjunction with optic specific cleaning cloths.

**CAUTION:** Using harsh chemicals may damage the optical coatings.

**NOTE:** Windage and elevation adjustment turrets are permanently lubricated. Do not attempt to lubricate them.

Cover turrets with supplied caps, except when adjusting them, to keep out dust and dirt.

**NOTE:** Eyepiece is permanently lubricated. Do not attempt to lubricate.

**NOTE:** Magnification Selector ring does not require lubrication

## MOUNTING YOUR NEW RIFLESCOPE

In order to optimize the capability of this Rifle scope, correct mounting is necessary. Crimson Trace recommends that a gunsmith or other qualified individual mount and verify that the scope is correctly installed.

- **Setting Eye Relief:** Start by attaching the lower portion of the rings to your firearm. Place the scope into the lower portion of the rings and loosely attach the top of the rings. Adjust the scope's magnification to the highest level and hold the firearm naturally with a proper cheek weld. While looking through the scope, move the scope forward and backward until the full field of view is visible. The edge of the image should be perfectly round with a sharp obvious transition to the black housing. Continue to move the scope forward until the edge of the field of view becomes obscured, this is the limit of the eye relief at maximum magnification. Move the scope slightly back towards the shooter until the full field of view is again visible and secure the scope in place. **NOTE:** It is at this point that you should verify the scope is level to the firearm before securing it in place. Always reference ring and base manufacturer's recommendations when securing your rifle scope.

EXAMPLE OF HOW TO MEASURE PROPER EYE RELIEF



PROPER EYE RELIEF ~3.5"

• **Focusing The Reticle:** The diopter adjustment, located at the rear portion of the rifle scope, is used to focus the reticle to each individual user's eye. In order to achieve the best focus, adjust the magnification to the maximum level and look into the scope at the reticle. There should not be a target, or other object in view. A flat, single color wall or the sky works best. Adjust the reticle into the best focus by turning the diopter. After you find the best focus, look away from the scope and allow your eye to relax for a few seconds. Look through the scope again and see if the reticle is still in focus, if not, adjust as necessary.

**NOTE:** The diopter adjustment is not intended to focus the target, only the reticle.

**NOTE:** Once proper reticle focus has been achieved, it generally will not require regular adjustment.

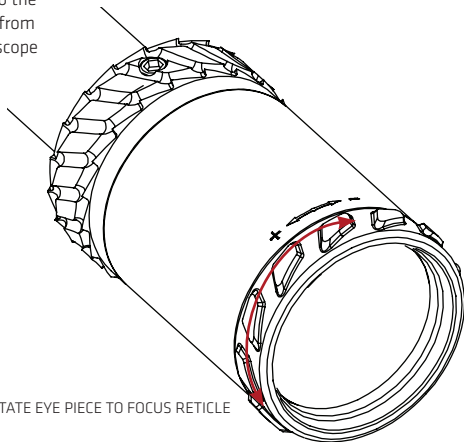

ROTATE EYE PIECE TO FOCUS RETICLE

## ZEROING YOUR NEW RIFLESCOPE

- **Achieving approximate zero by boresighting:** Once correctly mounted to your firearm, you are ready to boresight your Riflescope. Start by placing your firearm in a rest or on a bipod so that it is secured in place. Remove the bolt and look down the bore. Align the target so that it is centered and that both the muzzle and breach are concentric as shown. **NOTE: Use a 100 yard target for best results.** Next, with the firearm secured in place, turn the turrets to align the reticle to the same target. Once aligned, verify that your bore is still aligned to the target. Repeat as necessary until both the bore and reticle are aligned on the target. (See illustration #1.)

- **Range Zero:** Start your zero process by holding your reticle on the zero target. Generally, the smaller your zero target, the more precise you can be. Fire a three round group as precisely as you can, holding on the same point for all three. Try to ignore the point of impact until all three shots have been fired. If you pull a shot or make another aiming error, omit that round and fire another shot until you have an acceptable group of three. (See illustration #2.)

Observe your point of impact (POI) relative to your point of aim (POA) and measure the distance between the two. Your reticle is designed to help you measure and is subtended in increments that are consistent with your turret graduations. See illustration #3 for an example of how to use a reticle to measure your correction. Using your reticle manual as a guide, determine both the windage error and elevation error between your POA and POI. Make the adjustments to your windage and elevation accordingly.

**NOTE: The directions referenced on your dials refer to changes to the POI.** (See illustration #3.)

After making the adjustments, fire another 3 round group utilizing the original POA. This groups POI should be very close to your POA. Make the final adjustments as needed utilizing the method above. Confirm your zero by firing a final 3 round group. If the shooter does their part, the final group should match your POA and resemble target on the right. (See illustration #4.) Congratulations, you are now zeroed!

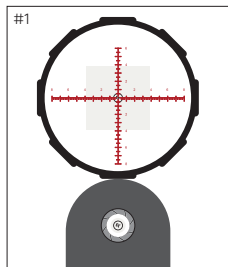

RETICLE AND BORE ARE ALIGNED



• **Resetting Turrets To Zero:** The elevation and windage adjustment turrets have a retracting system. Once zeroed, you will notice that your turrets likely do not read 0 and 0. To adjust this pull up on the elevation or windage adjustment turret to disengage. The turret can now be turned freely. Rotate each turret until the "0" is aligned with the zero position indicated on the scope, and then release the turret. The turret automatically retracts to the original position. (See illustration #5.).

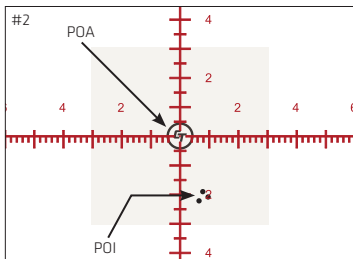

#2 AFTER FIRING YOUR 3 SHOT GROUP, YOUR TARGET SHOULD LOOK LIKE THE IMAGE ABOVE

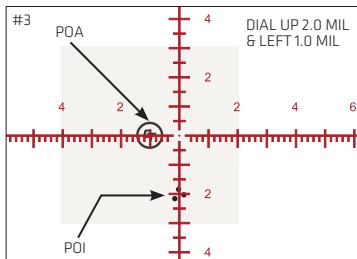

#3 MOVE YOUR RETICLE SO THAT IT INTERSECTS BOTH YOUR POA AND POI, AS SHOWN ABOVE. NOTE THE OFFSETS TO BOTH WINDAGE AND ELEVATION

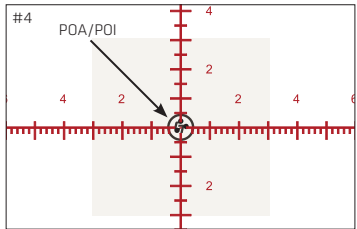
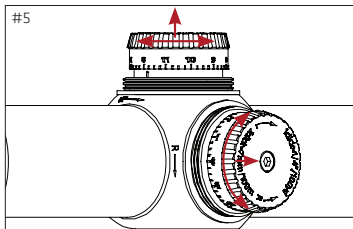

#4 POI NOW MATCHES POA

## COMMON CHALLENGES

- **Bad Groups:** The primary cause of poor grouping is ammunition. Rifles are very sensitive to minor changes in ammunition. Not all ammunition, even match ammunition, will perform perfectly in every rifle. Changes in manufacturers, bullet weights, or manufacturing processes will create varied results. It's best to experiment with several ammunition types from reputable manufacturers prior to finding the ideal combination for your rifle.

The second most common cause of poor grouping is improper scope mounting. Verify that you have followed the mount manufacturers recommendations. If these challenges persist, please contact customer service at 800-442-2406.

- **Unable to Zero:** If you are unable to zero the Riflescope to your rifle and ammunition combination, the most likely cause is misalignment between the action of the rifle (where the Riflescope is mounted) and the barrel (where the projectile goes).

Riflescopes have a limited amount of windage and elevation adjustment to correct this misalignment and occasionally this range of adjustability is too limited. If this is the case, a ring and base combination, with the necessary cant, may be available that offers a solution. Please consult ring and base manufacturers for further information.

## FULL LIFETIME WARRANTY

Crimson Trace Corporation (CTC) warrants that this product will be free from defects in materials and workmanship for the lifetime of the product. Terms and conditions apply. For complete warranty information please visit [www.crimsontrace.com/support/warranty](http://www.crimsontrace.com/support/warranty), or contact CTC at the address / telephone number listed on the back of this User Guide.

For warranty service call Customer Service at 800-442-2406, or email [customer@crimsontrace.com](mailto:customer@crimsontrace.com) for a Return Authorization Number (RMA).

**NOTES:**

---

---

---

---

---

---

---

---

---

---

---



***CRIMSON TRACE***<sup>®</sup>

CRIMSON TRACE HEADQUARTERS • 9780 SW FREEMAN DRIVE, WILSONVILLE, OR 97070  
TELEPHONE: 800-442-2406 • FAX: 503-783-5334 • [CRIMSONTRACE.COM](http://CRIMSONTRACE.COM)