

SIGSAUER[®]
when it counts[™]



SIG522[™]

OWNERS MANUAL: HANDLING & SAFETY INSTRUCTIONS

**READ THE INSTRUCTIONS AND WARNINGS IN THIS MANUAL CAREFULLY
BEFORE USING THIS FIREARM; DO NOT DISCARD THIS MANUAL.**

This instruction manual should always accompany this firearm and be transferred with it upon ownership,
or when the firearm is loaned or presented to another person.

State-By-State Warnings

Certain states require, by law, that their own specified warning notices, in larger-than-normal type be conspicuously included by the manufacturer, distributor, or retail dealer with firearms sold in that state. SIG SAUER sells its products in compliance with applicable laws and regulations. Because our products may be sold in these states, we include the following:

CALIFORNIA: WARNING

"Children are attracted to and can operate firearms that can cause severe injuries or death. Prevent child access by always keeping guns locked away and unloaded when not in use. If you keep a loaded firearm where a child obtains and improperly uses it, you may be fined or sent to prison."

ADVERTENCIA

"A los niños atraen las armas de fuego y las pueden hacer funcionar. Ellos pueden causarse lesiones graves y la muerte. Evite que los niños tengan acceso a las armas de fuego guardándolas siempre con llave y descargadas cuando no las esté utilizando. Si usted tiene una arma de fuego cargada en un lugar en que un niño tiene acceso a ella y la usa indebidamente, le pueden dar una multa o enviarlo a la cárcel."

CONNECTICUT:

"UNLAWFUL STORAGE OF A LOADED FIREARM MAY RESULT IN IMPRISONMENT OR FINE."

FLORIDA:

"IT IS UNLAWFUL, AND PUNISHABLE BY IMPRISONMENT AND FINE, FOR ANY ADULT TO STORE OR LEAVE A FIREARM IN ANY PLACE WITHIN THE REACH OR EASY ACCESS OF A MINOR UNDER 18 YEARS OF AGE OR TO KNOWINGLY SELL OR OTHERWISE TRANSFER OWNERSHIP OR POSSESSION OF A FIREARM TO A MINOR OR A PERSON OF UNSOUND MIND."

MAINE:

"ENDANGERING THE WELFARE OF A CHILD IS A CRIME. IF YOU LEAVE A FIREARM AND AMMUNITION WITHIN EASY ACCESS OF A CHILD, YOU MAY BE SUBJECT TO FINE, IMPRISONMENT OR BOTH. KEEP FIREARMS AND AMMUNITION SEPARATE. KEEP FIREARMS AND AMMUNITION LOCKED UP. USE TRIGGER LOCKS."

MARYLAND:

"WARNING: Children can operate firearms which may cause death or serious injury. It is a crime to store or leave a loaded firearm in any location where an individual knew or should have known that an unsupervised minor would gain access to the firearm. Store your firearm responsibly!"

MASSACHUSETTS:

"WARNING FROM THE MASSACHUSETTS ATTORNEY GENERAL: This handgun is not equipped with a device that fully blocks use by unauthorized users. More than 200,000 firearms like this one are stolen from their owners every year in the United States. In addition, there are more than a thousand suicides each year by younger children and teenagers who get access to firearms. Hundreds more die from accidental discharge. It is likely that many more children sustain serious wounds, or inflict such wounds accidentally on others. In order to limit the chance of such misuse, it is imperative that you keep this weapon locked in a secure place and take other steps necessary to limit the possibility of theft or accident. Failure to take reasonable preventative steps may result in innocent lives being lost, and in some circumstances may result in your liability for these deaths."

"IT IS UNLAWFUL TO STORE OR KEEP A FIREARM, RIFLE, SHOTGUN OR MACHINE GUN IN ANY PLACE UNLESS THAT WEAPON IS EQUIPPED WITH A TAMPER RESISTANT SAFETY DEVICE OR IS STORED OR KEPT IN A SECURELY LOCKED CONTAINER."

NEW JERSEY:

"IT IS A CRIMINAL OFFENSE TO LEAVE A LOADED FIREARM WITHIN EASY ACCESS OF A MINOR."

NEW YORK CITY, NY:

"THE USE OF A LOCKING DEVICE OR SAFETY LOCK IS ONLY ONE ASPECT OF RESPONSIBLE FIREARMS STORAGE. FOR INCREASED SAFETY, FIREARMS SHOULD BE STORED UNLOADED AND LOCKED IN A LOCATION THAT IS BOTH SEPARATE FROM THEIR AMMUNITION AND INACCESSIBLE TO CHILDREN AND OTHER UNAUTHORIZED PERSONS."

NORTH CAROLINA:

Any person who resides in the same premises as a minor, owns or possesses a firearm, and stores or leaves the firearm (i) in a condition that the firearm can be discharged and (ii) in a manner that the person knew or should have known that an unsupervised minor would be able to gain access to the firearm, is guilty of a Class 1 misdemeanor if a minor gains access to the firearm without the lawful permission of the minor's parents or a person having charge of the minor and the minor:

- (1) Possesses it in violation of G.S. 14-269.2(b)
- (2) Exhibits it in a public place in a careless, angry, or threatening manner;
- (3) Causes personal injury or death with it not in self defense; or
- (4) Uses it in the commission of a crime.

TEXAS:

"IT IS UNLAWFUL TO STORE, TRANSPORT, OR ABANDON AN UNSECURED FIREARM IN A PLACE WHERE CHILDREN ARE LIKELY TO BE AND CAN OBTAIN ACCESS TO THE FIREARM."

WISCONSIN:

"IF YOU LEAVE A LOADED FIREARM WITHIN THE REACH OR EASY ACCESS OF A CHILD YOU MAY BE FINED OR IMPRISONED OR BOTH IF THE CHILD IMPROPERLY DISCHARGES, POSSESSES, OR EXHIBITS THE FIREARM."

Please check with your licensed retailer, state police, or local police for additional warnings, which may be required by local law or regulation. Such regulations change constantly, and local authorities are in the best position to advise you on such legal matters.

 **WARNING - LOCKING DEVICES**



This firearm was originally sold with a key-operated locking device. While it can help provide secure storage for your unloaded firearm, any locking device can fail. All guns are designed to fire if they are loaded and the trigger is pulled. Therefore, never install the locking device inside the trigger guard or in any way that makes it possible to pull the trigger! Do not leave the keys in the lock.

The ultimate responsibility for secure storage of any firearm must depend upon its owner and his or her individual circumstances. Firearms should be stored unloaded, in a secure location, separate from their ammunition.



**NEVER INSTALL THE
LOCKING DEVICE INSIDE
THE TRIGGER GUARD**

To maximize effectiveness and reduce the chances of malfunction or damage to a firearm, ALWAYS refer to the locking device's manufacturer directions for installation and removal of the device.

FIREARMS SAFETY IS YOUR RESPONSIBILITY

This owner's manual is designed to assist you in learning how to use and care for your SIG SAUER® rifle properly.

Only when you are certain that you fully understand this manual and can properly carry out its instructions, should you practice loading and firing your firearm with live ammunition. Having a gun in your possession is a full-time job; you cannot guess and you cannot forget. You must know how to use your firearm safely.

If you have any doubts about your ability to handle or use this firearm safely, you should seek supervised instruction. The Sig Sauer Academy™ provides all levels of firearms safety and skill training, from beginner to expert.

For more information contact:



www.sigsaueracademy.com • (603) 679-2003

Main campus: Epping, New Hampshire
Satellite Facilities: Range 82, Midland, VA
NRA Whittington Center, Raton, NM

**SAFETY MUST BE THE FIRST AND CONSTANT CONSIDERATION OF EVERY PERSON WHO
HANDLES FIREARMS AND AMMUNITION.**

For more information about safety, responsible firearms ownership, and shooting sports, contact:
National Rifle Association (NRA) of America
11250 Waples Mill Road, Fairfax, VA 22030-7400 • 1-800-672-3888
www.nra.com

TABLE OF CONTENTS

Topic	Page	Topic	Page
State-By-State Warnings	2	5.0 Unloading	36
Locking Device	6	6.0. Procedures In Case Of Malfunction ("Jam")	40
General Safety Information	11	6.1 Troubleshooting Guide	41
1.0 Safety Information	11	6.2 Minimizing Malfunctions ("Jams")	42
1.1 Protect Your Eyes And Ears	12	7.0 Disassembly	43
2.0. Mechanical Characteristics and Weapon Theory	12	7.1 Reassembly	45
2.1 Weapon Description	12	7.2 Function Check	46
2.1.1 General	12	Magazine Inspection and Care	48
2.1.2 Main Components	14, 15	Care and Cleaning	49
2.1.3 Receiver Assembly	16	Transportation & Storage	49
2.1.4 Hand Guards	16	9.0 Maintenance	50
2.1.5 Trigger Casing Assembly	16	9.1 Cleaning the Rifle	51
2.1.6 Manual Safety	16	Service and Parts Policy	52
2.1.7 Sights	17	Shipping Firearms for Repair	53
2.1.8 Magazine	17	Ordering Parts	55
2.2 Technical Specifications	18	10.0. Parts List	56
Operation of Safety	19	10.1. Parts Diagram	57
Ammunition	20	The Basic Rules of Safe Firearms Handling	58
3.0. Handling	26	Warranty Information	59
3.1 Important Instructions	26		
3.2 Loading The Magazine	27		
3.3 Loading The Rifle	28		
3.4 Changing the Magazine (Rifle Not Empty)	29		
3.5 Changing the Magazine (Rifle Empty)	30		
4.0. Ready to Fire	32		
4.1 Firing	33		

WARNINGS OF GREAT IMPORTANCE ARE FOUND WITHIN THIS MANUAL

Locking Devices	10	Manual Safety	21
Handling	26, 35	Jam	40
Alteration	10	Ammunition	22, 24
Firing	35	Storage	47
Sights	17	Lead Exposure	24
Unloading	38	Parts Purchasers	52
Lodged Bullet	24	Shipping	55

OTHER CAUTIONS AND WARNINGS APPEAR THROUGHOUT THE MANUAL

FIREARMS ARE DANGEROUS WEAPONS

**READ THE INSTRUCTIONS AND WARNINGS IN THIS
MANUAL THOROUGHLY AND CAREFULLY BEFORE USING.**

WARNING - ALTERATIONS



This product was designed to function properly in its original condition. Alterations can make it unsafe. Do not alter any part or add or substitute any parts or accessories not manufactured by SIG SAUER Inc.

DO NOT ALTER ANY GUN

GENERAL SAFETY INFORMATION AND MECHANICAL CHARACTERISTICS

1.0 Safety Information

The safety warnings in this manual are important. By understanding the dangers inherent in the use of any firearm, and by taking the precautions described herein, you can enjoy complete safety in the use of your rifle. Failure to heed any of these warnings may result in serious injury to you or others, as well as severe damage to the firearm or other property. SIG SAUER Inc. shall not be responsible in any manner whatsoever for malfunctioning of the firearm, physical injury or property damage resulting in whole or in part from:

- 1) criminal or negligent discharge;
- 2) improper or careless handling;
- 3) unauthorized modifications;
- 4) defective, improper, hand-loaded, or reloaded ammunition;
- 5) corrosion;
- 6) neglect; or
- 7) other influences beyond our direct and immediate control.

This limitation applies regardless of whether liability is asserted on the basis of contract, negligence, or strict liability (including any failure to warn). Under no circumstance shall SIG SAUER Inc. be liable for incidental or consequential damages, such as loss of use of property, commercial loss, and loss of earnings or profits.

1.1 Protect Your Eyes and Ears

Always wear safety glasses and ear plugs or " earmuff " type protectors whenever you are shooting. Always make certain that persons close to you are similarly protected. Unprotected eyes may be injured by powder, gas, carbon residue, lubricant, metallic particles, or similar debris which may emanate occasionally from any firearm in normal use. Without ear protection, repeated exposure to shooting noise may lead to cumulative, permanent hearing loss.

This page intentionally left blank.

2.0 Mechanical Characteristics and Weapon Theory

2.1 Weapon Description

2.1.1. General

The SIG522 Rifle is a semi-automatic, blowback operated weapon. Semi-automatic means one round will fire each time the trigger is pulled until the magazine is emptied of ammunition. The rifle is chambered for .22LR ammunition.

2.1.2 Main Components

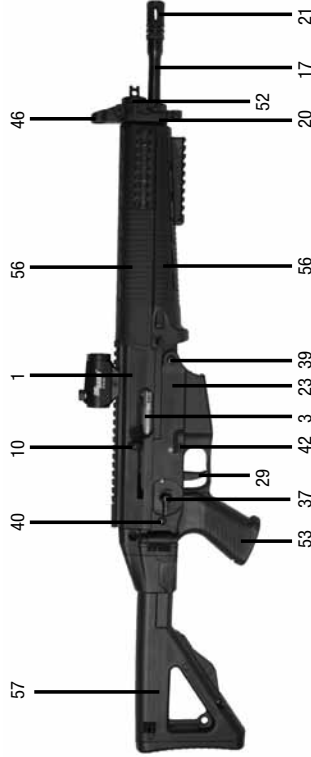

- | | | | | | |
|----|------------------|----|---------------------|----|----------------------|
| 1 | Receiver | 23 | Trigger Casing | 46 | Optional Front Sight |
| 3 | Bolt | 29 | Trigger | 52 | Storage Tube Plug |
| 10 | Charging Handle | 37 | Safety Lever | 53 | Rifle Grip |
| 17 | Barrel | 39 | Front Take Down Pin | 56 | Hand Guards |
| 20 | Gas Block | 40 | Rear Take Down Pin | 57 | Butt Stock |
| 21 | Flash Suppressor | 42 | Magazine Catch | | |



- | | | | | | |
|---|-----------------------------------|---|---------------------------------|---|------------------------------------|
| A | Front Sight, Adjustment Screw | G | Safety Lever | L | Magazine Catch |
| B | Storage Tube (beneath hand guard) | H | Optional Sling Attachment Point | M | Rifle Grip Storage |
| C | Upper Hand Guard | I | Optional Hand Guard | N | Folding Butt Stock Catch |
| D | Optional Optical Sight | J | Accessory Rails | O | Butt Stock Length Adjustment Lever |
| E | Bolt Stop Lever | K | Lower Hand Guard | P | Sling Attachment Points |
| F | M1913 Sight & Accessory Rail | | Magazine Well | Q | Replaceable Butt Pad |

2.1.3 Receiver Assembly

The barrel is mechanically mated to the receiver. The flash suppressor is screwed onto the muzzle end of the barrel which features a 1/2 x 28 TPI thread pattern. The gas block, which is fixed on the barrel, accepts the optional front sight, houses the storage tube, and also serves as support for the hand guards. The receiver guides the bolt and recoil system. An M1913 accessory mounting rail is machined into the receiver, providing an attachment point for optional sighting systems and other accessories.

2.1.4 Hand Guards

The hand guards protect the barrel and storage tube from damage. They provide ergonomic positioning of the hands during operation as well as protecting the hands from burns.

2.1.5 Trigger Casing Assembly

The trigger casing assembly contains the internal components of the firing and safety mechanisms, magazine well, magazine catch, trigger, and rifle grip. The folding butt stock mates to the trigger casing assembly via a hinged interface and adjusts for length.

2.1.6 Manual Safety

The safety lever, located on both sides of the trigger casing, can be set to two positions:

- Position "S:" The weapon is locked in the safe position.
- Position "F:" The weapon will fire in the semi-automatic mode.

S - SAFE



F - FIRE



2.1.7 Sights

The SIG522 rifle features an integrated M1913 accessory rail on the upper receiver for attaching a variety of sighting systems, both optical and fixed. The SIG522 accepts an optional Hooded Front Sight that provides an iron sight solution when combined with the optional fixed rear sight or Rotary Diopter Sight System designed for the SIG522.

Note: The Rotary Diopter Sight System for the SIG556 is NOT compatible with the SIG522, due to the difference in ballistics between .22LR and 5.56mm

WARNING - SIGHTS



Do not adjust or otherwise manipulate any sight system on the rifle without first confirming the magazine is removed, the rifle is on "SAFE" and fully unloaded. Failure to heed this warning could result in unintentional discharge, resulting in injury or death

UNLOAD PISTOL BEFORE MANIPULATING SIGHTS.

2.1.8 Magazine

The rifle ships with either

- (1) 25-round magazine or
- (1) 10-round magazine, depending on configuration.



2.2 Technical Specifications

Caliber	.22LR	
Bolt System	Blowback	
Cartridge Case Ejection	Right	
Modes of Fire	Semi-auto	
Stock	Folding; length adjustable	
Handguards	Polymer or Alloy	
Overall Length	35.1"	892mm
Length with Stock Collapsed	33.6"	853mm
Length with Stock Folded	26.1"	663mm
Width	3.0"	76mm
Height ¹	18.3"	211mm
Barrel Length	16.6"	422mm
Barrel Profile	6 grooves RH	
Rifling	1 in 16"	406mm
Sight Radius	18.1"	460mm
Weight without Magazine ²	5.4lbs	2.45kg
Trigger Pull ³	5.0lbs	23N / 2.3kg
Sights ⁴	Optional Hooded Front Sight	

Specifications are approximate and subject to change without notice.

¹ Top of sight to bottom of rifle grip - magazine excluded

² Polymer handguards - for alloy quad rail add 0.2lbs (91gr)

³ +/- 1.0lb (454gr)

⁴ Optional Hooded Front Sight, Optional Rotary Diopter Rear Sight M1913 quick detach; Optional Mini Red Dot Sight

Operation of Safety

The SIG522 has a manual safety which is located on the left and right side of the trigger casing, just forward of the rifle grip and above the trigger. The safety levers may be operated from either side.

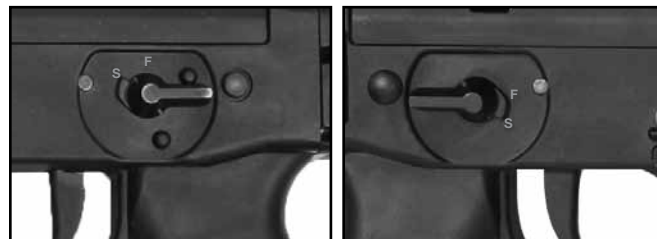

LEFT SIDE VIEW

RIGHT SIDE VIEW

The safety is "on" when the safety lever is in the "S" (SAFE) position. In this position, the rifle cannot be fired with a normal pull of the trigger. The safety lever should always be in the "S" (SAFE) position except when the shooter is actually firing the rifle. The safety lever should be moved to the "S" (SAFE) position whenever the shooter ceases firing, even temporarily.

The safety is "off" when the safety lever is in the "F" (FIRE) position. When the safety lever is in the "F" (FIRE) position the rifle will fire in the semi-automatic mode each time the trigger is pulled until all the ammunition is expended.

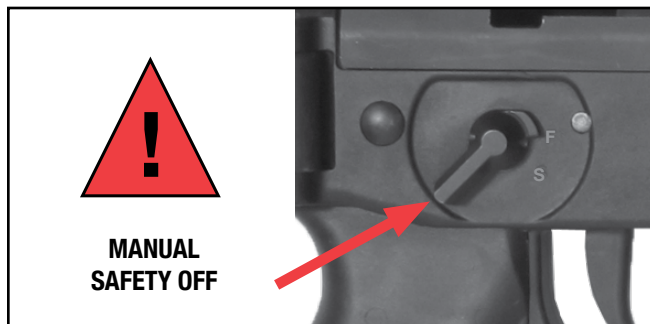
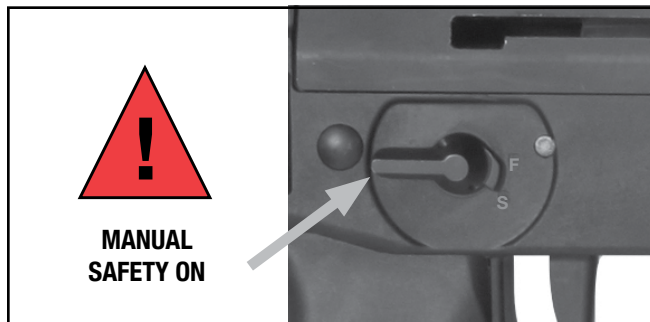

⚠ WARNING - MANUAL SAFETY



Keep the safety "ON" unless actually firing. Always move the safety to its intended position and check it. The safety is not "ON" unless it is completely "ON." Never depend on a safety mechanism or any other mechanical device to justify careless handling or permitting the rifle to point in an unsafe direction. The only "safe" rifle is one in which the bolt is open, the chamber is empty, and there is no magazine in the gun.

KNOW HOW TO USE THE SAFETY

Ammunition

1. Use only high quality, original, factory-manufactured ammunition. Do not use cartridges that are dirty, wet, corroded, bent, or damaged. Do not oil cartridges. Do not spray aerosol-type lubricants, preservative, or cleaners directly onto cartridges or where excess spray may flow into contact with cartridges. Lubricant or other foreign matter on cartridges can cause potentially dangerous ammunition malfunctions. Use only ammunition of the caliber for which your firearm is chambered. The proper caliber is permanently engraved on your firearm; never attempt to use ammunition of any other caliber.
2. The use of reloaded, "remanufactured" hand-loaded, or other non-standard ammunition voids all warranties. Reloading is a science and improperly loaded ammunition can be extremely dangerous. Severe damage to the firearm and serious injury to the shooter or to others may result. Always use ammunition that complies with the industry performance standards established by the Sporting Arms and Ammunition Manufacturers' Institute, Inc. of the United States (SAAMI) or ammunition manufactured to military specifications.



WARNING – AMMUNITION (CARTRIDGE) NOTICE

SIG SAUER SPECIFICALLY DISCLAIMS RESPONSIBILITY FOR ANY DAMAGE OR INJURY WHATSOEVER OCCURRING IN CONNECTION WITH, OR AS A RESULT OF, THE USE IN ANY SIG SAUER FIREARM OF FAULTY, NON-STANDARD, "REMANUFACTURED" HAND-LOADED (RELOADED) AMMUNITION, OR CARTRIDGES OTHER THAN THOSE FOR WHICH THE FIREARM WAS ORIGINALLY CHAMBERED.

3. Firearms may be severely damaged and serious injury to the shooter or to others may result from any condition causing excessive pressure inside the chamber or barrel during firing. Excessive pressure can be caused by obstructions in the barrel, propellant powder overloads, the use of incorrect cartridges or defectively assembled cartridges. In addition, the use of a dirty, corroded, or damaged cartridge can lead to a burst cartridge case and consequent damage to the firearm and personal injury from the sudden escape of high-pressure propellant gas within the firearm's mechanism.

4. Immediately stop shooting and check the barrel for a possible obstruction whenever:
 - You have difficulty in, or feel unusual resistance in, chambering a cartridge;
 - A cartridge misfires (does not go off);
 - The mechanism fails to extract a fired cartridge case;
 - Unburned grains of propellant powder are discovered spilled in the mechanism;
 - A shot sounds weak or abnormal. In such cases it is possible that a bullet is lodged part way down the barrel. Firing a subsequent bullet into the obstructed barrel can wreck the firearm and cause serious injury to the shooter or to bystanders.
5. Bullets can become lodged in the barrel:
 - If the cartridge has been improperly loaded without propellant powder, or if the powder fails to ignite (ignition of the cartridge primer alone will push the bullet out of the cartridge case, but usually does not generate sufficient energy to expel the bullet completely from the barrel);
 - If the bullet is not properly seated in the cartridge case. When such a cartridge is extracted from the chamber without being fired, the bullet may be left behind in the bore at the point where the rifling begins. Subsequent chambering of another cartridge may push the first bullet further into the bore.

6. If there is any reason to suspect that a bullet is obstructing the barrel, immediately unload the firearm and look through the bore. It is not sufficient to merely look in the chamber. A bullet may be lodged some distance down the barrel where it cannot easily be seen.

 **WARNING – LODGED BULLET**

IF A BULLET IS IN THE BORE, DO NOT ATTEMPT TO SHOOT IT OUT BY USING ANOTHER CARTRIDGE OR BY BLOWING IT OUT WITH A BLANK OR ONE FROM WHICH THE BULLET HAS BEEN REMOVED. SUCH TECHNIQUES CAN GENERATE EXCESSIVE PRESSURE, DAMAGE THE FIREARM, AND CAUSE SERIOUS PERSONAL INJURY.

If the bullet can be removed with a cleaning rod, clean any unburned powder grains from the bore, chamber, and mechanism before resuming shooting. If the bullet cannot be dislodged by tapping it with a cleaning rod, take the firearm to a gunsmith.

7. Dirt, corrosion, or other foreign matter on a cartridge can impede complete chambering and may cause the cartridge case to burst upon firing. The same is true of cartridges which are damaged or deformed.

8. Do not oil cartridges, and be sure to wipe the chamber clean of any oil or preservative before commencing to shoot. Oil interferes with the friction between cartridge case and chamber wall that is necessary for safe functioning, and subjects the firearm to stress similar to that imposed by excessive pressure.

9. Use lubricants sparingly on the moving parts of your firearm. Avoid excessive spraying of any aerosol gun care product, especially where it may get on ammunition. All lubricants and aerosol spray lubricants in particular can penetrate cartridge primers and cause misfires. Some highly penetrative lubricants can also migrate inside cartridge cases and cause deterioration of the propellant powder; on firing, the powder may not ignite. If only the primer ignites, there is danger that the bullet may become lodged in the barrel.

 **WARNING - AMMUNITION**



Death, serious injury, and damage can result from the use of wrong ammunition, bore obstructions, powder overloads, or incorrect cartridge components. Always wear shooting glasses and hearing protectors.

IMPROPER AMMUNITION DESTROYS GUNS

 **WARNING - LEAD EXPOSURE**



Discharging firearms in poorly ventilated areas, cleaning firearms, or handling ammunition may result in exposure to lead and other substances known to the state of California to cause birth defects, reproductive harm, and other serious physical injury. Maintain adequate ventilation at all times. Wash hands thoroughly after exposure.

SHOOTING OR CLEANING GUNS MAY EXPOSE YOU TO LEAD

To Load and Fire (with Magazine)

3.0 Handling

3.1 Important Instructions

- Before manipulating the rifle, ensure the safety lever is in the “S” (SAFE) position.
- Use only factory-new ammunition which corresponds to the caliber of the rifle.
- During all handling of the rifle, point the rifle in a safe direction.
- Do not place your finger on the trigger until the target has been verified and you intend to shoot.
- Do not load the rifle until immediately before use. Unload rifle immediately after shooting is finished.
- Remove the magazine and all ammunition from the rifle prior to transportation.



WARNING - HANDLING



Never carry the rifle loaded with the safety lever in the “F” (FIRE) position. If dropped or struck with the safety off (“F”), the rifle may fire. Such a discharge can occur with or without the trigger being directly struck or touched. Never rest a loaded rifle against any object (wall, tree, fence, vehicle, etc.) because there is always the possibility that the rifle will be jarred or slide from its position and fall with sufficient force to discharge. Keep the safety lever on “S” (SAFE) unless actually firing.

ANY GUN MAY FIRE IF DROPPED

3.2 Loading The Magazine

1. Ensure the magazine is the proper type and caliber;
2. Hold the magazine vertically;
3. Place a round between the feed lips and press down - ensure the bullet is facing the front of the magazine; and
4. Place the next round on top of the previous round and repeat until the desired number of rounds are loaded.

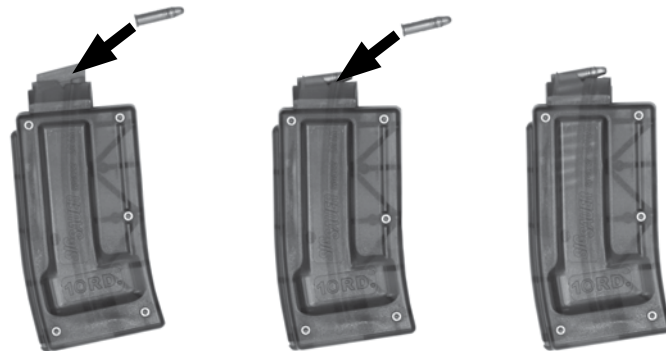

3.3 Loading The Rifle

1. Ensure the safety lever is in the "S" (SAFE) position;
2. Insert the magazine and check that it is properly seated;
3. Pull the charging handle back fully and release.

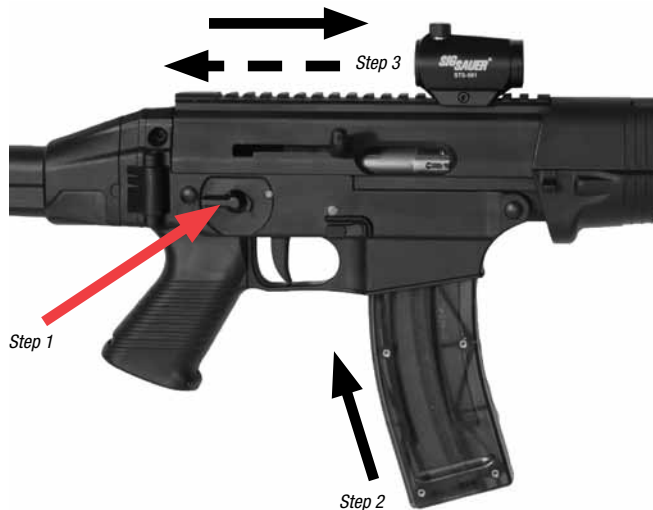

⚠ WARNING

DO NOT LOAD A PISTOL WITH A HOT CHAMBER BECAUSE A ROUND MAY "COOK" OFF (i.e., a round may detonate (fire) unexpectedly just because it is exposed to the heat of the rifle's chamber).

3.4 Changing The Magazine (Rifle Not Empty)

Note: When the bolt is fully closed (forward) the rifle is not empty and there is ammunition in the chamber

1. Ensure the safety lever is in the "S" (SAFE) position;
2. Remove the magazine by depressing the magazine catch;
3. Insert loaded magazine and check that it is properly seated;
4. Move the safety lever to the "F" (FIRE) position and continue shooting.

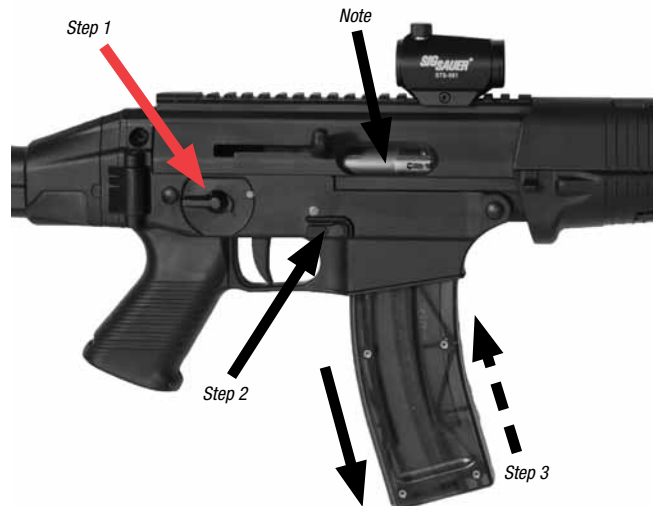

3.5 Changing The Magazine (Rifle Empty)

Note: The bolt will be held partially open by the magazine follower when all ammunition in the magazine has been expended and the rifle is empty (visually check the chamber to verify).

1. Ensure the safety lever is in the "S" (SAFE) position;
2. Lock the bolt open by pulling charging handle fully rearward and depressing bolt stop lever (rear button);
3. Remove the empty magazine by depressing the magazine catch;
4. Insert a loaded magazine and check that it is properly seated;

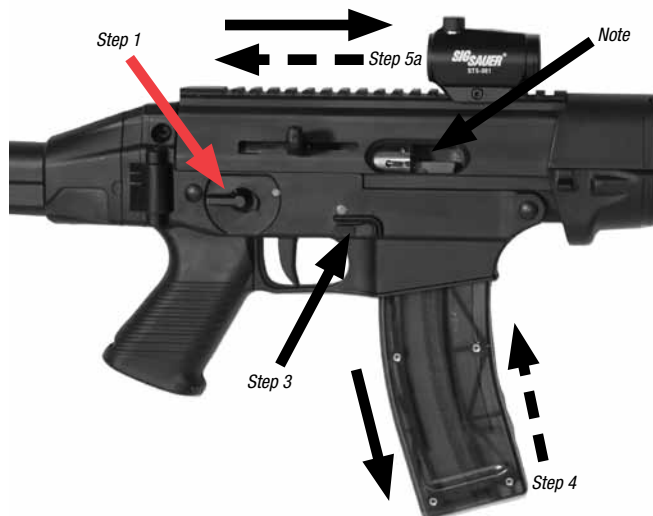

- 5a. Pull the charging handle fully to the rear and release; or
- 5b. Depress bolt stop lever (toward button) to release bolt;
6. Move the safety lever to the "F" (FIRE) position and continue shooting.

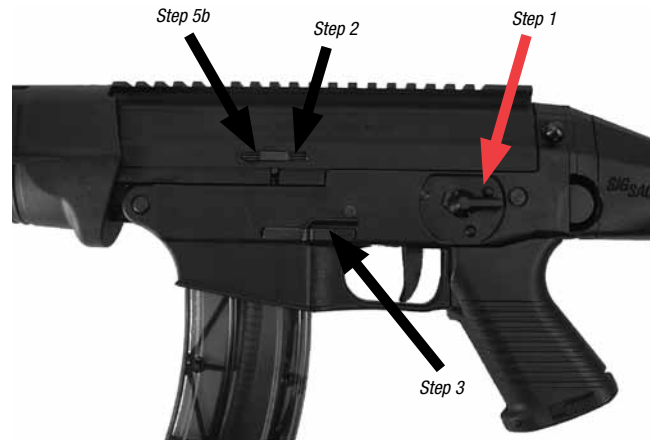

 **WARNING**

Always make sure the muzzle is pointed in a safe direction! Never attempt to load or unload any firearm inside a vehicle, building, or other confined space (except a properly constructed shooting range). Enclosed areas frequently offer no completely safe direction to point the firearm; if an accidental discharge occurs, there is great risk of bodily injury or property damage. Before loading, always clean all grease and oil from the bore and chamber, and check to be certain that no obstruction is in the barrel. Any foreign matter in the barrel could result in a bulged or burst barrel or other damage to the firearm, and could cause serious injury to the shooter or to others.

4.0 Ready To Fire

The rifle is in a "ready to fire" condition when the bolt is fully forward, the hammer is cocked, and there is ammunition in the chamber.

 **WARNING**

DO NOT TOUCH THE TRIGGER UNTIL YOU ARE ACTUALLY READY TO FIRE THE PISTOL.

4.1 Firing

1. Move the safety lever to the "F" (FIRE) position.
2. Depress the trigger, firing a single round in the semi-automatic mode.
3. Continue until firing is complete.
4. Move the safety lever to the "S" (SAFE) position
5. See Section 5.0 Unloading The Rifle



 **WARNING**

Immediately following the firing of a shot, if a subsequent shot is not fired at once, put the safety lever in the “S” (SAFE) position and point the rifle in a safe direction. The safety should be moved to the “S” (SAFE) position as soon as firing is completed, and it should be “on” at all times except when the rifle is targeted and being fired.

Keep the muzzle pointed in a safe direction and your finger away from the trigger when cocking any firearm.

Never carry or leave unattended any firearm which is cocked and ready to fire! When cocked, it could fire from slight pressure on the trigger. An accidental discharge could easily result if you fall or drop the firearm, or if the firearm is struck or disturbed by someone or something.

Never fire any firearm with your finger, hand, face, or other part of your body over or adjacent to the ejection port, or in any position where you may be struck by reciprocating movement of the breech. Both the ejection of empty cartridge cases and the movement of the breech are part of the normal operating cycle of firearms, and pose no safety hazard to the shooter if the firearm is held in a normal grip and fired at arm’s length.

Never allow other persons to stand beside you where they might be struck by an ejected cartridge case. The case is hot, and may be ejected with sufficient force to cause a burn, cut or injury to an unprotected eye. Make certain there is a clear, unobstructed path for safe ejection of the fired case. Remember, the case may bounce off a hard object nearby and strike you or someone else.

If, while shooting, your firearm develops a mechanical malfunction or binding, or “spits” powder/gas, or if a cartridge primer is punctured or a cartridge case is bulged or ruptured,

or if the report on firing does not sound quite right, STOP SHOOTING IMMEDIATELY! It may be dangerous to continue. UNLOAD THE FIREARM — do NOT try “one more shot”. Take the firearm and the ammunition to a gunsmith for examination. While shooting any firearm, an unfired cartridge or fired cartridge case may occasionally become jammed between the bolt and the barrel. Clear the jam as follows, WHILE KEEPING THE MUZZLE POINTED IN A SAFE DIRECTION: Remove the magazine, then pull back the bolt by way of the charging handle and hold it to the rear. The jammed cartridge or case now can be removed by shaking it out or picking it out.

 **WARNING – FIRING**



The bolt automatically opens and shuts quickly while firing. Keep face and hands away from it. Hot brass and powder gas is ejected quickly and can burn you. The rifle should be fired from the right shoulder. Always wear shooting glasses and hearing protectors.

BOLT OPENS FAST – HOT BRASS EJECTED

 **WARNING – HANDLING**



If dropped or struck with the safety “off,” the rifle may fire. Keep chamber empty unless actually firing! Keep safety in the “S” (SAFE) position unless actually firing!

ANY GUN MAY FIRE IF DROPPED

To Unload Magazine and Rifle

5.0. Unloading

1. Ensure the safety lever is in the "S" (SAFE) position;
2. Remove magazine by depressing the magazine catch;
3. Pull the charging handle fully to the rear and lock bolt open using the bolt stop lever (see section 3.5 item 2);



4. Verify the chamber is empty, both visually and physically;
5. Allow the bolt to close only on an empty chamber.

Step 4

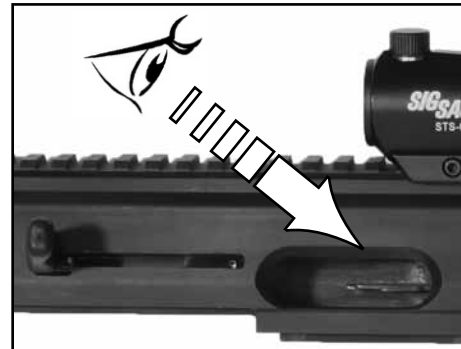

- Always make sure the muzzle is pointed in a safe direction!
- Remember to clear the chamber after the magazine has been removed.
- Never assume that any gun is unloaded until you have personally checked it, visually and physically!
- After every shooting practice, make a final check to be certain the firearm is unloaded before leaving the range.

! WARNING – UNLOADING



Removing cartridges from the magazine does not prevent the rifle from being fired! When there is a cartridge in the chamber and the safety lever is in the "F" (FIRE) position, the cartridge will discharge if the trigger is pulled. It is absolutely essential for the user to know how to completely unload the rifle.

"Completely" means emptying the magazine and removing a chambered cartridge.
THE SAFETY LEVER SHOULD ALWAYS BE IN THE "S" (SAFE) POSITION WHEN THE RIFLE IS BEING UNLOADED.

**THE PISTOL WILL FIRE EVEN
IF THE MAGAZINE IS EMPTY OR REMOVED**

To Extract and Eject A Chambered Cartridge

When the rifle is fired, the same gas pressure which drives the bullet forward also acts through the cartridge case to push the bolt to the rear. That action causes extraction and ejection of the fired case. But, when the bolt is operated by hand, there can be a failure to extract the cartridge from the chamber, or a failure to eject the cartridge clear of the rifle. These failures usually are the result of the bolt not being pulled rearward vigorously, coupled with an accumulation of firing residue in the chamber.

From the foregoing it is clear that the gun user must:

1. Always visually check the chamber after opening the bolt to eject a chambered cartridge. If the bolt is not vigorously retracted when being operated by hand, the extracted cartridge can be "ejected" into the magazine area instead of outside the rifle. (Remember that the magazine should be removed prior to unloading the chamber.)
2. Thoroughly clean the chamber and the extractor as often as necessary to prevent accumulation of grease and dirt.
3. If an empty magazine is in the rifle when the bolt is being hand retracted to extract a cartridge, the cartridge may drop on top of the magazine. Then, when the bolt goes forward, the cartridge will be chambered again! Always remove the magazine before clearing the chamber, and visually ensure that no cartridges remain in the rifle.

6.0 Procedures in Case of Malfunction (“Jam”)

Follow the malfunction mitigation procedures if:

- You notice that a cartridge is difficult to chamber
- A cartridge does not go off
- The mechanism fails to extract a fired cartridge case
- You discover unburned grains of propellant powder spilled in the mechanism
- A shot sounds or feels weak or abnormal

WARNING – JAM

LIVE ROUND JAM MAY NOT EJECT.

Firearms work reliably if properly maintained. If there is a malfunction during firing:

1. Keep the rifle pointed in a safe direction with your finger off the trigger.
 2. Remove and secure the magazine.
 3. Move the bolt rearward and forward to clear any cartridge case in or near the chamber. Visually and manually inspect the chamber.
 4. If you suspect that a bullet is lodged in the bore, field strip your rifle and check to see if the barrel is blocked. If there is a bullet lodged in the bore, return the rifle to SIG SAUER (see page 53 “Shipping Firearms for Repair”).
-

WARNING – JAM

IF A BULLET IS IN THE BORE, DO NOT ATTEMPT TO SHOOT IT OUT BY USING ANOTHER CARTRIDGE, OR BY BLOWING IT OUT WITH A BLANK OR A CARTRIDGE FROM WHICH THE BULLET HAS BEEN REMOVED. THIS CAN GENERATE EXCESSIVE PRESSURE, DAMAGE THE FIREARM AND CAUSE SERIOUS PERSONAL INJURY OR DEATH.

6.1 Troubleshooting Guide

Malfunction	Cause	Correction
Feed		
No round fed into the chamber	Magazine not properly inserted or magazine is deformed or dirty	Insert magazine properly or change magazine
Slide does not close easily or completely	Rifle or cartridge is fouled (dirty) or rifle is too heavily lubricated	Clean and lubricate rifle and/or replace the ammunition
	Incorrect ammunition	Replace ammunition
	Rifle requires service	Return to SIG SAUER
Extraction/Ejection		
After firing, the case stays in the chamber or is jammed in the ejection port	Insufficient recoil due to dirt	Clean and lubricate the rifle
	Light hold or limp wrist	Solid grip, rigid hold
	Low-powered ammunition	Change ammunition
	Rifle requires service	Return to SIG SAUER
Ignition		
Hammer drops but round does not fire	Firing pin obstructed	Inspect, clean and lubricate the rifle
	Faulty ammunition	Manually cycle in next round
	Rifle requires service	Return to SIG SAUER

⚠ WARNING

If your rifle stops firing with a live round in the chamber of a hot barrel (a misfire or jam), remove the round immediately. If you cannot remove the round within 10 seconds, remove the magazine and wait at least 15 minutes with the rifle pointing in a safe direction. This way, neither the user nor any other person would be injured by the possibility of a round “cooking-off” (a round detonating due to the heat of the barrel). Keep your face away from the ejection port while clearing a hot chamber.

6.2 Minimizing Malfunctions (“Jams”)

Malfunctions can largely be avoided by cleaning the rifle (see section 8.3 “Cleaning the Rifle”).

- After each firing session
- Whenever a buildup of firing residue is suspected
- Whenever the rifle is exposed to extreme environmental conditions (rain, snow, freezing temperatures, etc.)

7.0 Disassembly

1. Unload rifle (see section 5.0) – visually and physically check to ensure the rifle is clear of all ammunition;

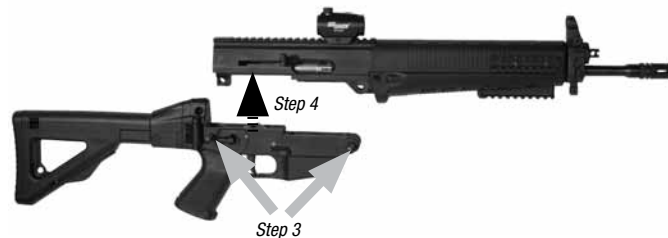

3. Retract the front and rear takedown pins – the pins are captive and will not fully remove;
4. Separate the trigger casing from the receiver;



5. Pu
6. Pull the charging handle outward and remove from the bolt;

7. Remove bolt and recoil spring assembly from the receiver;
8. Pull lower hand guard rearward and down to remove;
9. Pull upper hand guard upward and back to remove, exposing the storage tube (located above barrel and behind the gas block).

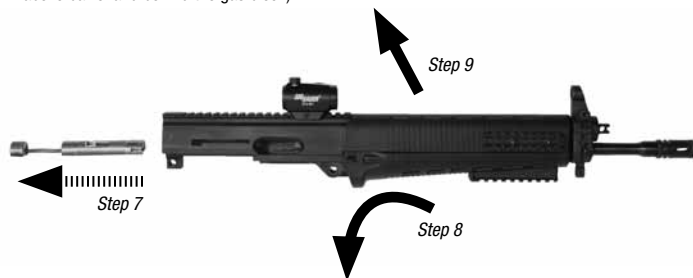

This level of disassembly is all that is required, or recommended, to adequately clean and lubricate the rifle. Further disassembly should only be attempted by factory trained technicians.



7.1. Reassembly

The rifle should always be reassembled in the reverse order of disassembly:

1. Install the upper hand guard:
 - a. Insert the front into the gas block.
 - b. Push the rear downward until seated.
2. Install the lower hand guard:
 - a. Press the hand guard upward against the upper hand guard, ensuring the locking tabs are aligned with each other.
 - b. Press the lower hand guard forward until the front is secured by the gas block and the pivot pin notch is aligned.
3. Insert the bolt and recoil spring into the rear of the receiver.
4. Slide the bolt forward until the charging handle notch is aligned with the receiver charging handle window.
5. Insert the charging handle through the window and into the bolt.
6. Slide the bolt and recoil spring assembly forward until the bolt is fully closed and the recoil spring assembly is flush with the rear of the receiver.
7. Connect the receiver and trigger casing assemblies and secure together by pressing in the front and rear takedown pins fully.
8. Perform a function check in accordance with Section 7.2.

7.2. Function Check

The function check described below should be performed whenever the rifle is disassembled and reassembled, or whenever proper function of the rifle is suspect.

1. Unload weapon (see section 5.0) — visually and physically check to ensure the rifle is clear of all ammunition;
2. Place the safety lever in the "S" (SAFE) position;
3. Pull the bolt fully to the rear and release;
4. Pull the trigger — the trigger must remain blocked and the hammer must not release;
5. Rotate the safety lever to the "F" (FIRE) position;
6. Pull the trigger and hold — the trigger is not blocked and the hammer releases (falls);
7. With the trigger held to the rear, pull the bolt fully to the rear and release — the hammer must not release;
8. Release the trigger and pull the trigger again — the trigger is not blocked and the hammer must release (fall);



WARNING - STORAGE



Never place or store any firearm in such a manner that it may be dislodged. Firearms should always be stored securely and unloaded, away from children and other unauthorized users. Use the locking device originally supplied with this firearm for storage. The use of a locking device or safety lock is only one aspect of responsible firearms storage. For increased safety, firearms should be stored unloaded and locked in a location that is both separate from their ammunition and inaccessible to children and any other unauthorized person.

STORE SECURELY & UNLOADED

MAGAZINE INSPECTION AND CARE

Inspect the magazine frequently. The magazine follower must move freely and have adequate spring tension so that each cartridge is quickly raised to the feeding position. The magazine lips should be clean and free of cracks, dents, or nicks, so that cartridges are held in their proper feeding position.

When cleaning is necessary, use a solvent that will not rust the metal components or adversely affect the magazine follower. After the magazine has been soaked in solvent to loosen foreign matter, be certain to shake it vigorously (with the loading opening away from you) to remove solvent or residue from within the magazine. **Penetrating oils and solvent inside a magazine can “kill” or weaken cartridge primers, which can result in failures to fire or other possibly dangerous malfunctions, such as leaving a bullet in the bore!**

After cleaning, always check to be certain that the magazine follower movement and spring tension are correct, and that no solvent or debris remain. **Improper reassembly of the magazine spring can cause a potentially dangerous malfunction. If cleaning does not restore proper tension, or if you experience a problem with the magazine, do not use it. Get a new one. DAMAGED, NON-STANDARD, OR IMPROPERLY ASSEMBLED MAGAZINES SHOULD NOT BE USED. THEY CAN CAUSE THE PISTOL TO MALFUNCTION.**

CARE AND CLEANING

1. Your rifle is delivered factory packaged and preserved with a light coating of protective grease and oils. Before loading make certain that all packing grease and oil has been cleaned from the bore and exposed mechanism.

2. Before you begin to disassemble your firearm for cleaning, always double-check to make sure it is unloaded!

3. After cleaning always check to be sure that no cleaning patch or other obstruction remains in the bore or chamber!

4. For maintenance guidelines, see section 9.0

TRANSPORTATION AND STORAGE

When transporting your firearm to and from shooting activities, keep it unloaded for your safety and for the safety of others. When storing your firearm, keep it separated from ammunition, under lock and key if possible, and out of the reach of children and other inexperienced or unauthorized persons.

MAINTENANCE

9.0. Maintenance

All firearms require periodic maintenance and inspection which may reveal a need for adjustment or repair. Have your firearm checked by a competent gunsmith annually even if it seems to be working well, since breakage, improper functioning or corrosion of some components may not be apparent from external examination. **If you notice any mechanical malfunction, DO NOT continue to use the firearm. UNLOAD the firearm and take it to a competent gunsmith immediately for a thorough examination.** Similarly, if water, sand, or other foreign matter enters the internal mechanism, immediately dismantle the firearm for a complete and thorough cleaning. **Failure to keep your firearm clean and in proper working order can lead to a potentially dangerous condition and an accident causing serious bodily injury or property damage may result.**

9.1. Cleaning the Rifle

The SIG522 rifle must be cleaned after each shooting session or whenever performance is suspect. Clean the rifle as follows:

1. Unload the weapon per Section 5.0;
2. Field strip the weapon per Section 7.0;
3. Clean the barrel and chamber from the rear;
4. Clean other parts of the rifle, using care to remove carbon and firing residue. Pay particular attention to the chamber areas, and bolt face, which should be addressed every 500 rounds.
5. Lightly lubricate areas of metal contact with a high quality firearms lubricant or grease, paying particular attention to the bolt, recoil spring assembly, and receiver rails;
6. Apply a light coating of high quality firearms lubricant or grease to exposed metal surfaces to enhance corrosion protection;
7. Reassemble the rifle per section 7.1; and
8. Perform a function check in accordance with section 7.2.

SERVICE AND PARTS POLICY

Parts Policy

Our Service Department maintains a full complement of replacement parts. Even though most gunsmiths have the knowledge, training, and the ability to make necessary repairs to your firearm, the skill and workmanship of any particular gunsmith is totally beyond our control.

Should your firearm ever require service, we strongly recommend that you return it to SIG SAUER Inc. (see page 53). A firearm is a precision instrument and some replacement parts will require individual fitting to ensure correct operation. A wrong part, improper fitting, or incorrect mechanical adjustment may result in an unsafe condition or dangerous malfunction, damage to the firearm, or cause possible serious injury to the shooter or others.

IF ANY PART IS ORDERED WITHOUT RETURNING THE FIREARM TO SIG SAUER Inc., the customer bears full responsibility for ensuring that the part supplied is correct for their particular firearm and is properly installed and fitted by a qualified gunsmith.

SIG SAUER INC. CANNOT BE RESPONSIBLE FOR THE FUNCTIONING OF ANY FIREARM IN WHICH REPLACEMENT PARTS ARE INSTALLED BY OTHERS.



WARNING – PARTS PURCHASERS

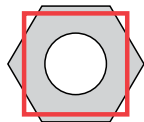

It is the purchaser's responsibility to be absolutely certain that any parts ordered from the factory are correctly fitted and installed. Firearms are complicated mechanisms and **IMPROPER FITTING OF PARTS MAY RESULT IN A DANGEROUS MALFUNCTION, DAMAGE TO THE FIREARM, AND SERIOUS INJURY TO THE SHOOTER AND OTHER PERSONS.** The

purchaser and installer of parts must accept full responsibility for the correct adjustment and functioning of the firearm after such installation. **PARTS MUST FIT CORRECTLY**

Service Policy

If you have questions concerning the performance or servicing of your firearm, please write or call:

SIG SAUER, Inc.
Attention: Customer Service
18 Industrial Drive Exeter, NH 03833
Phone: (603) 772-2302
Fax: (603) 772-9082

IF YOU DO NOT UNDERSTAND THE INSTRUCTIONS FOR OPERATING YOUR PISTOL, IT IS YOUR RESPONSIBILITY TO CALL OUR CUSTOMER SERVICE DEPARTMENT AT (603) 772-2302 BEFORE USING YOUR FIREARM.

Shipping Firearms for Repair

In the event you need to return your firearm to the SIG SAUER Service Department, here's what to do:

1. First contact Customer Service at (603) 772-2302 for an RMA number, which will allow SIG SAUER to track the status of your return from its receipt at SIG SAUER through its return to you. **Please do not send your firearm until you obtain an RMA number.**
2. Make sure that the chamber and magazine(s) are unloaded and that no ammunition is included with your returned firearm.
3. Package the firearm securely to prevent damage. Enclose a letter that includes your name, street address, daytime phone number, model and serial number, and a detailed description of the problem you have experienced or the work you want performed. With the exception of extra magazines, do not include any other accessories such as scopes or mounts.

4. Generally, an individual may ship firearms to the manufacturer for repair or service. Some states and localities, however, prohibit this. If you live in such an area, the firearms must be shipped by and returned to a federally licensed firearms dealer.

5. Federal law prohibits persons who do not possess a Federal Firearms License from shipping a firearm via the U.S. Postal Service. (Note: any shipment of firearms outside U.S. borders is subject to the export laws of the United States and to the valid laws of the specific country, which you must strictly follow; prior to exporting any firearm you should seek legal counsel.)

6. SIG SAUER is not responsible for any firearm until it is received, nor for damage incurred during shipment.

Don't forget to write your RMA number on the package.

This instruction manual should always accompany this rifle and be transferred with it upon change of ownership.

WARNING: BEFORE SHIPPING ANY FIREARM, BE ABSOLUTELY CERTAIN THAT THE FIREARM AND ITS MAGAZINE ARE UNLOADED. DO NOT SHIP CARTRIDGES WITH A FIREARM.

7. Ship your firearms insured and prepaid (we do not accept collect shipments) to:

SIG SAUER, Inc.
Attention: Service Department
18 Industrial Drive Exeter, NH 03833

Ordering Parts

In the event you want to order parts for your firearm, contact Customer Service at (603) 772-2302.

Have available the serial number of your firearm and the part diagram number for the part(s) you wish to order. A parts list and diagram of the rifle is provided in section 10.0 and 10.1.

Please refer to the Service and Parts Policy on pages 52, 53, and 54.

WARNING – SHIPPING



Before shipping any firearm, be absolutely certain that the firearm and its magazines are unloaded.

DO NOT ship ammunition with a firearm. Failure to follow this warning could result in unintentional discharge, causing injury or death.

VERIFY THE FIREARM IS UNLOADED

10.0 Parts List

Item	Description	Item	Description
1	Receiver	34	Disconnecter
2	Set Screw, Gas Block	35	Safety Shaft
3	Bolt	36	Safety Detent Spring
4	Firing Pin	37	Safety Lever
5	Firing Pin Spring	38	Safety Lever Spring Pin
6	Firing Pin Retaining Pin	39	Front Takedown Pin
7	Extractor	40	Rear Takedown Pin
8	Extractor Plunger	41	Takedown Pin Plunger
9	Extractor Spring	42	Right Magazine Catch
10	Charging Handle	43	Left Magazine Catch
11	Charging Handle Cover	44	Magazine Catch Pivot Pin
12	Buffer	45	Magazine Catch Spring
13	Recoil Spring Guide	46	Front Sight (optional)
14	Recoil Spring	47	Front Sight Screw Assembly (optional)
15	Recoil Spring Washer	48	Front Sight Screw (optional)
16	Recoil Spring Guide E-Clip	49	Front Sight Nut (optional)
17	Barrel	50	Front Sight Spring Pin (optional)
18	Ejector	51	Storage Tube
19	Barrel Nut	52	Storage Plug
20	Gas Block	53	Rifle Grip
21	Flash Suppressor	54	Rifle Grip Screw
23	Trigger Casing	55	Rifle Grip Nut
24	Hammer Pivot Pin	56	Hand Guards
25	Hammer	57	Folding Stock Assembly
26	Hammer Spring	58	Folding Stock Hinge Pin
27	Trigger Pivot Pin	59	Folding Stock Disc Spring
28	Trigger Bushing	60	Sling Plug
29	Trigger Assembly	61	Take Down Spring
30	Trigger Brace	62	Bolt Stop
31	Trigger Spring	63	Bolt Stop Pin
32	Sear	64	Spring, Bolt Stop
33	Sear Spring		

10.1 Parts Diagram



THE BASIC RULES OF SAFE FIREARMS HANDLING

1. ALWAYS treat every gun as if it were loaded.
2. ALWAYS be sure the barrel is clear of any obstruction.
3. ALWAYS be sure of your backstop, what lies beyond, and the safety of bystanders before you shoot.
4. ALWAYS use clean, dry, original factory-made ammunition of the proper type and caliber for your gun.
5. ALWAYS wear ear protection and safety glasses when shooting.
6. ALWAYS carry your gun so that you can control the direction of the muzzle if you fall or stumble.
7. NEVER shoot at a flat surface or water.
8. DO NOT leave an unattended gun loaded. Guns and ammunition should be stored separately, locked if possible, beyond the reach of children, careless adults, and unauthorized users.
9. NEVER allow your firearm to be used by anyone who has not read and understood this operator's manual.
10. DO NOT point any gun, loaded or unloaded, at any undesired target.
11. NEVER fire your rifle near an animal unless it is trained to accept the noise: an animal's startled reaction could injure it or cause an accident.
12. NEVER drink alcoholic beverages or take drugs before or during shooting, as your vision and judgment could be seriously impaired, making your gun handling unsafe.

SIG SAUER® Limited Lifetime Firearms Warranty

SIG SAUER® warrants that the enclosed firearm was originally manufactured free of defects in material, workmanship and mechanical function. For the lifetime of the original purchaser, SIG SAUER agrees to correct any defect in the firearm for the original purchaser by repair, adjustment or replacement, at SIG SAUER's option, with the same or comparable quality components (or by replacing the firearms at SIG SAUER's option); provided, however, that the firearm is returned unloaded and freight prepaid to:

SIG SAUER
18 Industrial Drive
Exeter, NH 03833

This limited warranty is null and void if the firearm has been misused, damaged (by accident or otherwise), fired with handloaded, reloaded or improper ammunition, fired with an obstruction in the barrel, damaged through failure to provide reasonable and necessary maintenance as described in the manual accompanying the firearm, or if unauthorized repair or any alteration, including of a cosmetic nature, has been performed on the firearm. This limited warranty does not apply to normal wear and tear of any parts. Subject to the foregoing, this limited warranty confers the right to have the covered firearm or its parts repaired, adjusted or replaced exclusively upon the original purchaser, which right is not transferable to any other person. No implied warranties of any kind are made herein and this warranty does not apply to any accessory items attached or appurtenant to the firearm. In no event shall SIG SAUER be liable for any incidental or consequential damages arising from or in connection with this limited warranty.

SIGSAUER[®]
when it counts[™]

www.sigsauer.com

**FOR PRODUCT SERVICE ON THIS MODEL,
PLEASE CALL (603) 772-2302**

18 Industrial Drive, Exeter, NH 03833 USA