

# Charles Daly®

The Shooting Sports Specialist™

SAFETY & INSTRUCTION MANUAL

## 601 Semi-Auto Field Shotgun



READ THE INSTRUCTIONS & WARNING IN THIS  
MANUAL CAREFULLY BEFORE USING THIS FIREARM

## PURCHASER'S RECORD

Model # \_\_\_\_\_

Purchase Date: \_\_\_\_\_

Gauge/Caliber: \_\_\_\_\_

Serial #: \_\_\_\_\_

Purchase Price: \_\_\_\_\_

Store Name: \_\_\_\_\_

**Charles Daly®**

# TABLE OF CONTENTS

Warnings.....	4
Safety Rules.....	5-6
Identifying Marking.....	7
Description & Specs.....	7
Nomenclature.....	7
Safety Selector/Button.....	7-8
Barrel Assembly.....	8-9
Loading.....	9
Unloading.....	10
Disassembly.....	10-11
Reassembly.....	11-12
Installation of Magazine Plug.....	12
Exploded View & Parts List.....	13-14
Usage of Choke Tubes.....	15
Cleaning & Maintenance.....	16
Warranty Conditions.....	17-18



**WARNING - DO NOT DRY FIRE**

# WARNINGS

The manufacturer is not responsible for damage to objects caused by misuse of the firearm or for injuries to persons or animals, or in case of death, caused voluntarily or involuntarily by the firearm user. The manufacturer is not responsible for injuries caused by poor maintenance, misuse of the firearm, unauthorized or improper modifications.

The manufacturer declines responsibility for the indirect consequences of any injuries and/or death of persons or animals, damage to objects caused by use of the firearm or by primer explosion, by bullet's ricochet, or unsafe loading practices and/or procedure.

Read the entire manual and learn the proper use of the firearm without live ammunition. It is important that you understand the proper use of this product. The life of the people close to you may depend on your safe behavior.

If the manual is not clear, please contact the dealer where you bought the firearm or call the distributor or the manufacturer by using the contact information provided within this manual.

**The manufacturer declines any responsibility for misuse of the firearm. In case of alteration of the firearm, The manufacturer declines any civil and penal responsibility and will not refund any damage.**

**Quality Inspection:** Every firearm is thoroughly inspected by the manufacturer, for function and cosmetic blemish, prior to shipment.

To guarantee the firearm is safe, all firearms produced in the Italian facility are sent to the National Proof House in Gardone Val Trompia - Brescia, Italy for proof testing, in compliance with Italian law. The Proof House tests the firearm with heavy loads then checks the barrel, chamber and head space to make certain the firearm is safe for use with standard factory ammunition. The National Proof House will put their markings on the firearm, certifying the firearm is qualified and can be sold.

Firearms produced in our U.S. facility or Turkey are scrupulously tested at the manufacturing premises.

**⚠ WARNING: Discharging firearms in poorly ventilated areas, cleaning firearms, or handling ammunition may result in exposure to lead or other substances known to the State of California to cause birth defects, reproductive harm, and other serious physical injury. Have adequate ventilation at all times. Wash hands thoroughly after exposure.**

**ANY LEGAL DISPUTE WILL BE UNDER THE JURISDICTION OF A COURT IN THE STATE  
OF OHIO - USA, OR IN THE COURT OF BRESCIA - ITALY, AT OUR DISCRETION**

# SAFETY RULES

1. Read the instructions carefully before use. Reading the manual and careful examination of the firearm are fundamental to avoid any kind of problem.
2. Be aware that you are handling a firearm; therefore your knowledge and behavior may affect your life and those of the people close to you.
3. Firearms and ammunitions must be kept in separate places.
4. Always keep firearm and ammunitions out of reach of children.
5. Store the firearm in a clean, dry and airy place after use to avoid rust in mechanical parts that may cause serious problems in functioning after a period of inactivity.
6. The firearm must always be stored unloaded, always check that the chamber is empty.
7. Keep away from open flames or heating sources.
8. Never leave a loaded firearm unattended.
9. Never leave the firearm loaded, it could fall and cause injury and death. Always point the firearm in a safe direction, and handle it as though it were loaded. This is especially important when loading and unloading the firearm and when handing it to someone else. Never take someone's word that it is unloaded. Always make sure the firearm is unloaded before laying it down or handing it to someone else.
10. After use, clean and lubricate the inside of the barrel with appropriate oil. Grease or oil build up can cause excessive pressure and result in serious personal injuries. Before using the firearm again, inspect the barrel and chamber to make certain that there are no obstructions in the bore. Remove any oil residue with rod and dry patch before shooting.
11. Accumulation of rust in the barrel can cause excessive pressures resulting in serious injury and may cause the explosion of the barrel. A rusted, pitted or eroded barrel should be replaced.
12. Before shooting always check to ensure that the barrel is free of obstructions.
13. Never force a jammed action, this act could cause explosion of the round and consequent injury.
14. Use factory loaded ammunition of the caliber specified on the firearm barrel. Use of different calibers may cause serious personal injuries to you and to people close to you.
15. In case of misfire, manually extract the cartridge from the chamber. If firearm fails to fire when trigger is pulled, as a result of slow primer ignition (hang fire), keep muzzle pointed downrange for a minimum of 30 seconds. If the round does not fire, remove the magazine, clear the firearm and examine the ejected, unfired cartridge. If the indent from the firing pin is off center, light or absent, take the gun to a competent gunsmith. If the indent appears normal compared to other rounds, assume a faulty round, separate from other cartridges, reload and continue shooting.
16. Do not attempt to re-use unexploded ammunitions.
17. Never modify any parts of your firearm. Any alteration may cause serious personal injury and voids the warranty.
18. Only a qualified gunsmith may service the firearm for repair or serious maintenance.
19. Pay great attention during transportation and use. Mechanical safety devices can fail. Developing intelligent, good safety habits is the best way to prevent accidents.

# SAFETY RULES

20. Never rest your finger on the trigger until the very moment you wish to shoot. Always keep the safety on until you are ready to safely shoot at an intended target. Note: Safety devices on firearms are extras and are not a substitute for your proper and safe handling practices.
21. Always keep the firearm unloaded when transporting it from home to the shooting areas. Carefully check that cartridge chamber is empty.
22. When you walk around with the firearm in a shooting area, always keep the muzzle pointed in a safe direction.
23. Never run with a loaded firearm, do not cross any obstacle (fences or water courses, etc.) or walk where there is any possibility of slipping or falling without having your firearm unloaded and in safety position.
24. When selecting a place to shoot, always be absolutely sure of your target and the area behind it before you touch the trigger, making sure there is an adequate backstop which will stop and contain bullets. A bullet can travel through or past your target with a range up to 1.5 miles. If you have any doubt, do not shoot.
25. Never shoot against a solid surface or in a pool of water, the projectiles could ricochet and shoot toward any direction. Do not shoot up into the sky.
26. Keep all bystanders behind you, standing beside a shooter is not a safe position. Make sure all other shooters and bystanders are well away from the ejection port.
27. Do not smoke while handling, loading or shooting any ammunition, especially black powder. Keep black powder in a closed container at all times, re-closing the container after each and every use.
28. Never drink alcoholic beverages or take any drugs before or during shooting, as this not only constitutes criminal disregard for your safety and that of others, but will seriously impair your judgment and vision. Never use a firearm while you are taking medication unless you have checked with your doctor to ensure you are fit to handle the firearm safely.
29. Always wear and encourage others near you to wear proper ear protection when shooting, especially on a range since the noise from your firearm and other firearms close to you, could result in permanent hearing loss.
30. Always wear protective shooting glasses to protect your eyes from injury by gun powder, gas, lubricant, dirt or metallic particles, carbon residue, sparks or other debris.
31. Wash hands thoroughly after shooting and handling firearms to remove any unwanted residues.
32. Never leave the loaded firearm or the loaded magazine in the sun.
33. By replica firearms there is no modern safety. In this case you must pay even more attention to safety rules.

 **Remember:** No mechanical safety device is infallible. The user is responsible for injuries or damages caused to him or to other persons. Complete knowledge of your firearm can make the difference.

# IDENTIFYING MARKINGS

Every firearm we produce has a serial number that is marked on the receiver/frame. Close to the serial number you will also find the manufacturers information with the model name and caliber marked either on the frame or the barrel as required by law.

**These markings must not be removed from the firearm for any reason.**

## DESCRIPTION & SPECS

Your shotgun is gas operated. The gas created from firing a live shot shell operates the action. Once the first shell has been fired, the next shell in the magazine will automatically cycle into the chamber, and this cycle will continue (each time the trigger is pulled) until all shells loaded in the magazine have been fire. The bolt will remain locked in the open position after the last shell is fired.

The technologically advanced gas metering system allows you to shoot 2-3/4" and 3" shells interchangeably with any ammunition of the proper gauge for your shotgun with flawless performance. For 3-1/2" models the metering system allows you to shoot heavy 2-3/4", 3" and 3-1/2" shells interchangeably. This and other fine features ensure that your shotgun will be a source of pride and pleasure for years to come.

## NOMENCLATURE

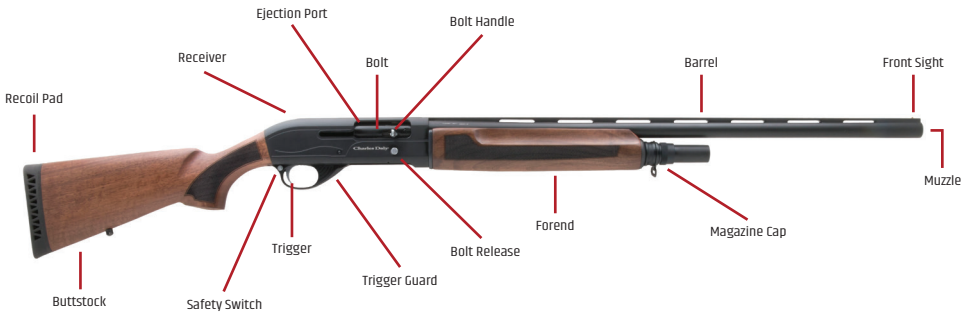

## SAFETY SELECTOR/BUTTON

The safety is designed to stop the trigger mechanism. **Do not rely on your firearms' safety, treat every firearm as if it were loaded and ready to fire.** The safety on any firearm is a mechanical device, and it is not intended as a substitute for common sense or safe firearms handling. Always keep the muzzle pointed in a safe direction.

- A. The safety is located behind the trigger, and provides protection against accidental or unintentional discharge under normal usage when properly used.
- B. To engage the safety, push the button so that it protrudes from the right side of the firearm and **RED BAND MARKING CAN NOT BE SEEN**. The safety should always be in the “on” or “safe” position until you intend to shoot. (Fig. 1)
- C. When you are ready to shoot the firearm, press the safety button to the “off” position so that the safety protrudes from the left side of the firearm and the **RED BAND MARKING IS SHOWING**.



**⚠ DANGER:** The firearm will fire when the trigger is pulled intentionally or accidentally when the **RED BAND MARKING IS SHOWING**.

## BARREL ASSEMBLY

In the packaging, your shotgun is divided into two parts: receiver and barrel (Fig. 2).



Follow the steps below to assemble the barrel:

1. Unscrew the magazine cap (Fig. 3) and remove the forend (Fig. 4).
2. Unscrew the barrel locking nut (Fig. 5).
3. Assemble the barrel over the magazine tube into the receiver. **Note:** You may need to push the bolt forward to allow clearance for insertion of the barrel (Fig. 6).
4. Install the barrel locking nut with knurled side facing down and hand tighten, making sure the barrel is fully seated into the receiver (Fig. 7).
5. Place the forend against the barrel and slide onto the magazine tube making sure it is fully seated. Screw the magazine cap onto the threaded magazine tube and hand tighten (Fig. 8).

View the 601 Barrel Assembly video at: [charlesdaly.com/videos](http://charlesdaly.com/videos)





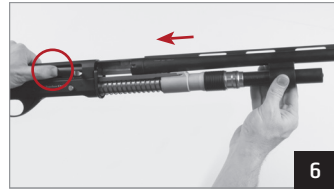
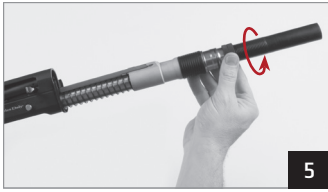

## LOADING

**Be sure the safety is in the "on" or "safe" position and the barrel is pointed in a safe direction.**

1. Push in the carrier on the bottom of the receiver and make sure there are no cartridges in the magazine tube (Fig. 9).
2. Press the carrier plunger and pull the bolt rearward locking into rear position (Fig 10). Visually inspect chamber for no cartridge then press the bolt release button (Fig. 11).
3. Begin loading the shotgun from the bottom by pushing cartridge through the carrier and into magazine tube until it is retained by the magazine release button/shell stop (Fig. 12). Repeat loading cartridges until desired amount is reached (5 Max. of 2-3/4" Cartridges).
4. Press the carrier plunger then pull and release the bolt. This will feed a cartridge into the chamber. An additional round can now be loaded into the bottom of receiver if desired otherwise your shotgun is ready to be fired when the trigger is pulled with the safety in the "off" or "fire" position.

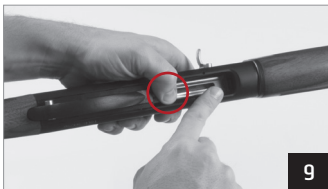

# UNLOADING

Be sure the safety is in the “on” or “safe” position and the barrel is pointed in a safe direction.

1. Press the carrier plunger (Fig. 13).
2. Pull and release the bolt. Repeat this until all cartridges are cleared (Fig. 14).
3. Bolt will lock in rear position once all cartridges are cleared.



# DISASSEMBLY

Be sure the safety is in the “on” or “safe” position and the barrel is pointed in a safe direction.

**⚠ CAUTION: Make sure the gun is unloaded.**

1. Make sure the bolt is in the forward position before disassembly (Fig. 15).
1. Unscrew the magazine cap (Fig. 16) and remove the forend (Fig. 17).
2. Unscrew the barrel locking nut (Fig. 18) and remove barrel. Most likely the gas pistol remained in the barrel gas port (Fig.19), remove and place it back onto the magazine tube.
3. Temporarily replace the barrel locking nut back on to the magazine tube with knurled side facing away from the receiver and tighten until it reaches the end of the threads (Fig. 20).
4. Remove bolt handle from bolt by aligning the opening in the bolt with the nub on the bolt handle and pulling outward (Fig. 21). It may be necessary to use a small flat head screwdriver to pry bolt handle out. Use caution and be careful not to damage the shotgun.
5. Slightly pull down and hold the action assembly and remove barrel locking nut from the magazine tube then slowly remove action assembly from the shotgun (Fig. 22).
6. To remove the trigger group use a small punch and hammer to punch the small retaining pin from the ejection port side (Fig. 23) and remove trigger group assembly (Fig. 24).



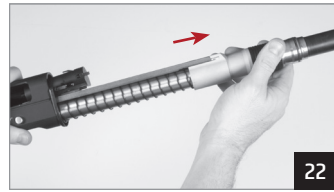
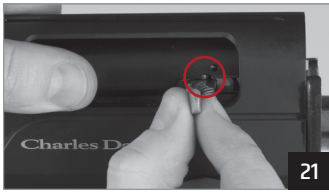

## REASSEMBLY

1. Insert trigger group from the back of the receiver and install retaining pin on the opposite side of the ejection port with knurled side of pin away from the receiver (Fig. 25). A hammer may be necessary to fully seat the pin. Please use caution not to damage your shotgun.
2. Assemble the action assembly and insert into receiver and onto magazine tube in reverse order of removal (Fig. 26). Hold the action assembly down and replace barrel locking nut with knurled side facing away from the receiver and tighten until it reaches the end of the threads (Fig. 27).
3. Align bolt with the slot in the action bar and insert bolt handle (Fig. 28).
4. Unscrew the barrel locking nut (Fig. 29).
5. Assemble the barrel over the magazine tube into the receiver. **Note:** You may need to push the bolt forward to allow clearance for insertion of the barrel (Fig. 30).
6. Install the barrel locking nut with knurled side facing down and hand tighten, making sure the barrel is fully seated into the receiver (Fig. 31).
7. Place the forend against the barrel and slide onto the magazine tube making sure it is fully seated. Screw the magazine cap onto the threaded magazine tube and hand tighten (Fig. 32).

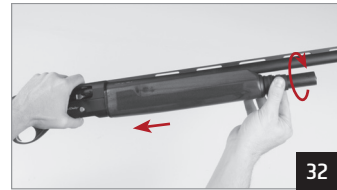
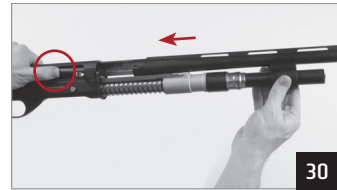
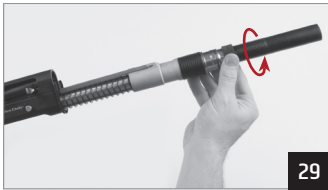
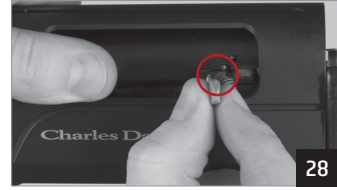
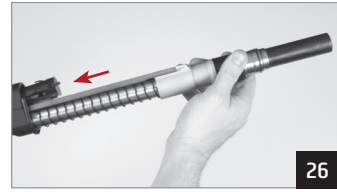

## INSTALLATION OF MAGAZINE PLUG

Some Federal, State and local hunting regulations may require that a shotgun be limited to a maximum shell capacity of three (3) rounds. Following the steps below to install the magazine plug:

1. Insert magazine plug into magazine tube (Fig. 25).
2. Install the plug collar over the magazine plug and press down at an angle into magazine tube until collar is capture by the magazine tube and release (Fig. 26).



# EXPLODED VIEW

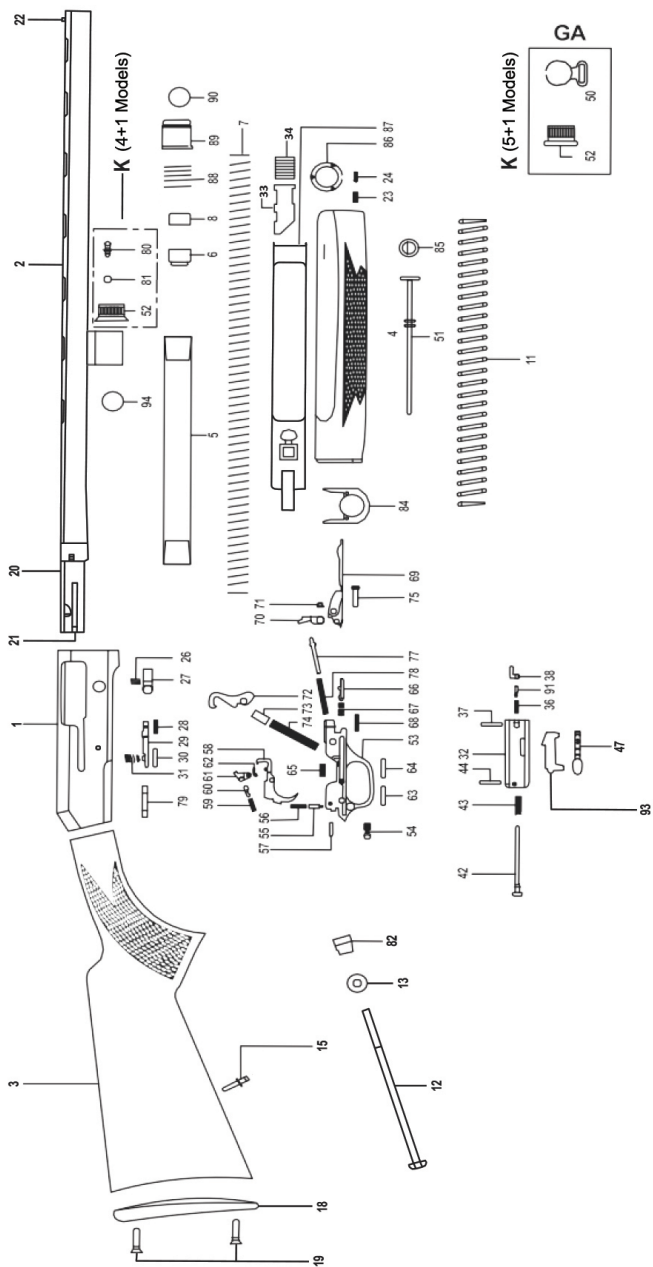

# PARTS LIST

<b>PART</b>	<b>DESCRIPTION</b>	<b>PART</b>	<b>DESCRIPTION</b>
1	Receiver	52	Magazine Cap
2	Barrel	53	Trigger Plate
3a	Stock - Wood	54	Safety Button
3b	Stock - Synthetic	55	Safety Plunger
4a	Forearm - Wood	56	Safety Spring
4b	Forearm - Synthetic	57	Safety Plunger Pin
5	Magazine Tube	58	Trigger
6	Magazine Follower	59	Sear Spring
7	Magazine Spring	60	Sear Plunger
8	Magazine Spring Retainer	61	Sear
11	Action Spring	62	Sear Pin
12a	Stock Bolt - Wood	63	Trigger Pin
12b	Stock Bolt - Synthetic	64	Trigger Stop Pin
13	Stock Bolt Washer	65	Trigger Spring
15	Stock Swivel Stud	66	Carrier Plunger
18a	Recoil Pad - Wood	67	Carrier Spring
18b	Recoil Pad - Synthetic	68	Carrier Retaining Pin
19	Recoil Pad Screw	69	Carrier
20	Barrel Extension	70	Carrier Latch
21	Ejector	71	Carrier Latch Pin
22	Front Bead	72	Hammer
23	Magazine Cap Spring (Wood Model Only)	73	Hammer Plunger
24	Magazine Cap Pin (Wood Model Only)	74	Hammer Spring
26	Bolt Release Button Spring	75	Trigger Plate Pin Sleeve
27	Bolt Release Button	77	Carrier Latch Plunger
28	Bolt Release Button Pin	78	Carrier Latch Spring
29	Bolt Release Latch	79	Trigger Plate Pin
30	Bolt Release Latch Pin	80	Swivel Stud
31	Bolt Release Latch Spring	81	Swivel Stud Retainer
32	Breech Bolt	82	Stock Bolt Receiver (Syn Model Only)
33	Action Bar Sleeve	84	Forend Plate
34	Piston Buffer	85	Magazine Plug Retainer
36	Extractor Spring	86a	Forend Cap - Wood
37	Extractor Pin	86b	Forend Cap - Synthetic
38	Extractor	87	Action Bar
42	Firing Pin	88	Barrel Locking Nut
43	Firing Pin Spring	89	Gas Piston
44	Firing Pin Retainer Pin	90	Gas Piston Seal
47	Operating Handle	91	Extractor Spring Plunger
50	Front Swivel	93	Locking Block
51	Magazine Plug	94	Rubber Gas Ring

# USAGE OF CHOKE TUBES

The choke controls how open or tight the pattern of the shot will be. The chart below lists the chokes available (from open to tight), and the corresponding marks that indicate the specific choke.

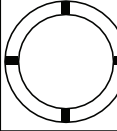
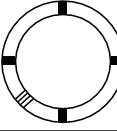
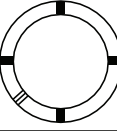
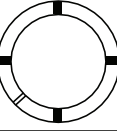
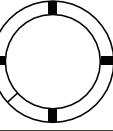
	SKEET	IC	M	IM	F
CHOKE TUBE					
BBLS	CL	★★★★	★★★	★★	★

Never fire your shotgun or run cleaning tools through a barrel that uses a choke tube without having a choke installed. The threads of the choke tube and the internal threads of the barrel should be cleaned after each use and before installation of the tube.

To install a tube, insert the tube into the top of the barrel and tighten with your fingers. Once the tube is finger tightened, tighten the rest of the way with the appropriate choke tube wrench until the tube is snug. **Do not over tighten or forcefully tighten with wrench.**

## **⚠ WARNING: Steel Shot Usage**

The choke (bore constriction) in all modern shotguns has been established based on the pattern performance of shot shells loaded with lead shot. When using steel shot shells you will notice a different performance in pattern density versus the established lead shot pattern, because the steel shot is harder and lighter than lead shot.

**You should be aware of the following differences and cautions: Never shoot steel shot loads in a full chokes barrel or an improved modified choked barrel. Doing so, might cause the barrel to swell or rupture.** In general, steel shot fired with a modified choke will produce the equivalent of a lead full choke pattern. This will be true of all steel shot sized up to an including No. 2. The established improved cylinder chokes will produce the equivalent of a (lead) modified pattern.

All steel shot larger than No. 2, and including special sized such as F, T, etc., should be used only with improved cylinder chokes. These steel shot sizes, when used in an improved cylinder choke, will produce the equivalent to (lead) full choke patterns. The established cylinder choke or bore will produce the equivalent of a modified (lead) pattern.

Additional information concerning the use of steel shot is available from the ammunition companies.

# CLEANING & MAINTENANCE

**⚠ CAUTION: Make sure the firearm is unloaded.**

1. Make sure the broad, polished finely fitting mating surface of the breech block and receiver is especially clean and lightly oiled with high quality gun oil. Do not use silicone, lanolin or WD-40.
2. Run an oil patch through the bore with a cleaning rod starting from the breech end. To prevent leading, use a cleaning solvent and brass brush to clean the bore periodically. Follow this cleaning with one or two clean oil patches. **Important:** If your gun is equipped with choke tubes, do not use a brass brush to clean the barrels without having a choke tube installed. Barrels that utilize choke tubes must also have the choke tubes removed to clean and oil the threads inside the barrel and the choke tubes themselves. This will protect the threads and prevent dirt build up that can cause tubes to become difficult to remove.

Never fire your gun without choke tubes completely tighten in barrels. Do not over tighten choke tubes. Wipe all exposed metal surfaces with an oiled cloth before storing. Do not squirt or pour oil into the mechanism because it may hamper proper functioning and will soak into the wood. After extended periods of heavy use, your gun should be taken to a qualified gunsmith to have the action disassembled for professional cleaning and lubrication.

3. Care for your wood stock and forearm the same way you would a piece of furniture with the same finish.

## STORAGE

Clean thoroughly and oil your firearm before storage. Store the firearm in a case to prevent scratches and dents. Store your firearm in a dry place to prevent corrosion. **Store the firearm away from children and in a place where it cannot be obtained by those unauthorized to use it. Always store firearm unloaded and separately from and ammunition.**

## HAZARDOUS MATERIAL WARNING

Discharging firearms in poorly ventilated areas, cleaning firearms, or handling ammunition, may result in exposure to lead and other substances known to cause birth defects, reproductive harm, and other serious injury. Have adequate ventilation at all times. Wash hands thoroughly after exposure.

## THANK YOU

Thank you for purchasing your firearm from us. We are certain it will bring you years of hunting and/or shooting pleasure. Your satisfaction is the key to our success. Please let us know if we can be of service and relay and observations about your firearms' performance or appearance.



# WARRANTY CONDITIONS

The manufacturer guarantees that our products are scrupulously checked against defects in materials, workmanship, aesthetics and functioning problems.

In case you find a defect in one of our products, you should immediately contact Chiappa Firearms or where you have bought your firearm. All warranty work will be performed by Chiappa Firearms.

**⚠ ATTENTION:** All customers returning product for warranty service must first obtain a return authorization from Chiappa Firearms. The request for a return authorization may be obtained through our web site, email or phone. Information required is name and address, model, serial number, and defect. It is the customer's responsibility for adequately packaging the product to prevent shipping damage.

The Charles Daly 5-year warranty guarantees for two years after the purchase date, free parts and labor for defects which have been found during use; wear of parts which shouldn't be subject to wear, or excessive wear of parts subject to wear and further supply free parts for an additional 3 years except for wood. Wood is covered for 1 year. The customer must provide evidence of the purchase date with a receipt or other valid proof.

In the event a defect which is covered by this guarantee is not repairable, the manufacturer will provide for a free substitution of the product.

**THE MANUFACTURER RESERVES THE RIGHT OF DEFINING THE TYPE OF DEFECT OF THE FIREARM AND THEREFORE TO STATE WHETHER THE DEFECT IS COVERED BY GUARANTEE.**

The manufacturer's decision will be fair but final. The manufacturer will be allowed a timing of 60 days for repair under guarantee, and 90 days for free substitution. Should the manufacturer become aware of a defect of a product during the guarantee period, the defective part will be replaced free of charge.

The guarantee does not cover parts subject to wear and corrosion. For assistance in obtaining a RMA (Return of Merchandise Authorization) contact the dealer where the products was purchased or call Chiappa Firearms USA, Ltd. at (937) 835-5000 or email at [service@chiappafirearms.com](mailto:service@chiappafirearms.com).

**⚠ ATTENTION: DELIVERY EXPENSES TO AND FROM THE SERVICE CENTER ARE NOT COVERED BY THE GUARANTEE AND WILL BE CHARGED TO THE CUSTOMER.**

# WARRANTY CONDITIONS

## The Guarantee Is Void In Case:

- Inadequate ammunition has been used (any ammunition but those commonly on sale, reloaded ammunition, different from caliber and specification indicated on the firearm barrel)
- The firearm failed to be provided proper maintenance and cleaning
- The firearm has been modified without our prior consent
- Unauthorized, inadequate or incorrect repairs have been carried out
- Non-original spare parts were used
- Parts subject to wear and corrosion
- Damage (improper use of the gun by the user)
- Expired guarantee

**In the above cases the repair, if completed, will be charged to the customer.**

In case, for any valid reason, you do not have the possibility to obtain repair under guarantee at the shop where you bought the firearm, you may contact us directly for warranty service or questions:

Chiappa Firearms USA, Ltd.  
1415 Stanley Ave, Dayton, OH 45429  
Tel: (937) 835-5000  
Email: info@chiappafirearms.com.

**THIS MANUAL MUST ALWAYS FOLLOW THE FIREARM,  
ALSO IN THE EVENT OF NEW OWNERSHIP.**

## Procedure For The Use Of Warranty:

1. Register your firearm on our website: <http://www.charlesdaly.com>
2. Contact the gun shop or dealer the firearm was purchased from, or Chiappa Firearms USA, Ltd. You will receive a RMA# and return instructions.
3. Fill in the form on next page, which will accompany the return firearm.
4. Ship the firearm to Chiappa Firearms USA, Ltd. in its original packing.

**⚠ ATTENTION:** The returned firearm must be protected with adequate packaging; any damages occurred during transportation and handling will be the customer's responsibility.

# RETURN MERCHANDISE FORM

To return your firearm for any reason, please call Customer Service at (937) 835-5000 for an RMA (Return of Merchandise Authorization).

## CUSTOMER INFORMATION

Name: \_\_\_\_\_ RMA# \_\_\_\_\_

Address: \_\_\_\_\_

City: \_\_\_\_\_ State: \_\_\_\_\_ Zip: \_\_\_\_\_

Phone: \_\_\_\_\_ Best Time to Call: \_\_\_\_\_

Email: \_\_\_\_\_

## PRODUCT INFORMATION

Model: \_\_\_\_\_

Serial #: \_\_\_\_\_

## GUN SHOP/ DEALER

Purchase Date: \_\_\_\_\_

Dealer Name: \_\_\_\_\_

Dealer Address: \_\_\_\_\_

## DESCRIPTION OF DEFECT

\_\_\_\_\_

\_\_\_\_\_

\_\_\_\_\_

\_\_\_\_\_

 **Remember:** Attach Proof of Purchase w/ Date

# Charles Daly®

The Shooting Sports Specialist™

---

CHARLESDALY.COM

**CHIAPPA®**  
f i r e a r m s

Exclusively Distributed by Chiappa Firearms USA, Ltd.

1415 Stanley Ave | Dayton, OH 45404 | Tel: 937-835-5000 | Email: info@chiappafirearms.com