

# HK416 .22

## OPERATOR'S MANUAL



HECKLER & KOCH

Caliber .22 LR  
Semi-Automatic Rifle/Pistol

Made in Germany by Umarex



**WARNING:** Read the instructions and warnings in this manual carefully before using this firearm.





**HECKLER & KOCH**

# **HK416 .22**

## **OPERATOR'S MANUAL**

This **INSTRUCTION MANUAL** should always accompany the firearm and be transferred with it upon change of ownership or when presented to another person. A copy of the **INSTRUCTION MANUAL** is available **FREE** upon request from:

**HECKLER & KOCH**

**Sales + Warranty Service • 5675 Transport Blvd. • Columbus, GA 31907**

**[www.hk-usa.com](http://www.hk-usa.com)**

## TABLE OF CONTENTS

1.1	Safety Operating Instructions .....	5
1.2	Safe Storage and transportation .....	8
1.3	Preparation for firing.....	9
1.4	Ammunition .....	10
1.5	Manual safety.....	11
2.1	Inspection.....	12
2.2	Loading the Firearm.....	12
2.3	Loading the first Cartridge .....	13
2.4	Firing.....	14
2.5	Decocking .....	15
2.6	Firearm with empty Magazine .....	16
2.7	Unloading.....	16
2.8	Clearing Misfires.....	17
3.1	Settings - Sights.....	17
3.2	Settings - Stock.....	18
3.3	Settings - Bolt Speed.....	19
4.1	Mounting an Optical Sight.....	19
4.2	Compartment Store .....	20
5.1	Field stripping.....	20
5.2	Maintenance.....	21
5.3	Storage.....	22
5.4	Repair .....	23
5.5	Warranty.....	23
6.1	Technical Data .....	25
6.2	Variants.....	25
6.3	Identification.....	26
	Contact.....	Back

---

**Safety is your number one responsibility!**

---

**At home, in the field, at the range, or anywhere, the first concern of every firearm owner should be safety. Apply the following safety rules in every situation, with any kind of firearm.**

---

**You must follow all of these safety rules to ensure the safe use of your firearm.**

---

---

**Safe gun handling is your personal responsibility!**

---

Safe use of a firearm is your personal responsibility and the failure to follow all of these basic safety rules may result in severe personal injury or death to you or others. You are the most important safety device when it comes to the use of your firearm. HECKLER & KOCH will not be responsible for any personal injury, death or property damage that results from:

1. The criminal or negligent use of this firearm;
  2. A disregard of these safety instructions and warnings;
  3. Improper or careless handling of this firearm;
  4. The use of non-standard, defective, improper or reloaded ammunition; or
  5. Improper or negligent modifications or repair to the firearm.
- **Safe gun handling is your personal responsibility at all times.** Firearms are dangerous and can cause serious injury or death if they are misused or used inappropriately. Safety must be the first consideration of anyone who owns or handles firearms.
  - **You are responsible for firearm safety at all times.** You must undertake full-time responsibility for your firearm's safety and security. You must protect yourself and all others against injury or death from misuse of the firearm.
  - **Safe firearm storage is your responsibility.** You must secure firearms safely from children and unauthorized users. A lock has been provided for use with this firearm. Never assume that the use of this lock is sufficient to safely secure your firearm. You must always evaluate your personal situation and employ the security system(s) that meet your needs and prevent children and unauthorized users from gaining access to your firearm.
  - **Accidents are the result of violating the rules of safe gun handling and common sense.**
  - For your safety and the safety of others, **never rely on mechanical features alone.** Only your safe gun handling habits will ensure the safe use of the firearm. This is your responsibility.
  - **Never keep ammunition in the same location as the firearm.** Store in a separate and secure place.

- **Do not alter, modify or replace any of the parts of the internal components of your firearm.** All work must be performed by an HECKLER & KOCH authorized gunsmith. If you do otherwise, improper functioning may occur, serious injury or death may result, and your warranty will be voided.
- **Never manipulate, adjust or change any of the internal components of your firearm** including the firing pin, sear, or drawbar. Improper manipulation of any internal component may affect the safety and reliability of your firearm and may cause serious injury.
- **Read and understand these instructions before using your firearm.**

---

**WARNING! The failure to follow these basic firearm safety rules may result in an unintended discharge which could cause serious personal injury or death to you and others.**

---

- **Before handling any firearm, understand its operation.** Not all firearms are the same. Familiarize yourself with the mechanical features of any firearm you intend to use. If you feel uncertain about any operational aspects of your firearm, please contact Heckler & Koch before proceeding with its operation.
- **Always safely store and secure your firearm.** Safe and secure storage of your firearm is one of the most important responsibilities of firearm ownership. It is a full-time responsibility. You must always secure your firearm and ammunition separately so that they are not accessible to children or other unauthorized persons. (See safe storage instructions in this manual).
- **Always keep your firearm pointed in a safe direction.** Never point this firearm at any person. Never point at anything you do not intend to shoot whether or not the firearm is loaded. This is particularly important when loading, unloading, or field stripping the gun.
- **Always control the direction of the muzzle.**
- **Never place your finger on the trigger or inside the trigger guard unless you intend to fire.** Ensure that other objects do not touch the trigger.
- **Always be sure of your target and what is beyond it.** Always be sure of where the bullet will strike and shoot only where there is a safe backstop free of obstructions, water or other surfaces which can cause ricochets. Think of what the bullet may hit if it misses the target or ricochets. Do not fire into the sky.
- **Never disassemble your firearm or manipulate the internal components of your firearm.** Beyond the field stripping procedure outlined in this manual. Improper disassembly or manipulation of your firearm may be dangerous and can lead to serious injury or death.

- **Never carry or store a firearm with the hammer or striker in the cocked position.**
- **Never allow your firearm to be used by individuals who have not read or do not understand these firearm safety rules.**
- **Be sure all accessories, such as holsters and grips, are compatible with the firearm** and that the accessories do not interfere with the safe operation.
- **Always use the correct ammunition for your particular firearm** as indicated by the marking on the barrel or receiver. Never use non-standard, reloaded, or “hand loaded” ammunition which has not been subjected to internal ballistic pressure testing.
- **Always have adequate ventilation.** Discharging firearms in poorly ventilated areas, cleaning firearms, or handling ammunition may result in exposure to lead and other substances known to cause birth defects, reproductive harm, and other serious physical injury. Review the warning and labels for all ammunition and cleaning products carefully.
- **Never use alcohol or drugs before or while shooting.** Do not use your firearm if you are on any medication which impairs, even slightly, your mental and/or physical ability.
- **Always wear eye and hearing protection specified for firearm use** every time you discharge your firearm. Make sure others in the vicinity of where you will be shooting wear protection as well.
- **Never allow any alteration or replacement of parts in your firearm unless performed by a qualified HECKLER & KOCH gunsmith.** If you do otherwise, improper functioning of your firearm may occur and serious injury or death may result.
- **Never cross obstacles such as fences or streams with a loaded firearm.**
- Firearm safety training is available. Contact your dealer, law enforcement agency, local sportman’s club, or the nra for availability.
- **Appropriate use for your firearm means using your firearm for legal purposes.**

---

**WARNING! Safe and secure storage of your firearm is one of the most important rules of firearm safety. Your failure to follow these rules may result in serious injury or death to you or others.**

---

- **You must always secure your firearm and ammunition separately** so that they are not accessible to children or other unauthorized persons.
- **Safe and secure storage and transportation of your firearm is your responsibility.** It is a full-time responsibility.
- **You should always secure your firearm in a manner that will prevent unauthorized access.** Always store your firearm unloaded. Your firearm and ammunition should be stored separately and in a manner inaccessible to children and unauthorized persons.
- **Always make certain that your firearm is safely secured in a manner so as to prevent unauthorized access to the firearm. HECKLER & KOCH has provided a lock for this purpose.** Please read and follow the instructions for the use of this lock. There are other alternative locks and safe storage containers available in the marketplace which may be appropriate for your particular needs. Consult your local gunshop, hardware store or local police department for guidance on the variety of other safe storage devices or practices which may be appropriate for your particular needs. By purchasing this firearm you have taken on the responsibility of safely securing the firearm at all times and preventing its unauthorized use. Never assume that the use of only a lock is sufficient to safely secure your firearm. It is your personal responsibility to select and use whatever measure or practices that will best enable you to be absolutely certain that your firearm is secure at all times.

**You are responsible to determine which devices or practices are appropriate  
For the safe storage of your firearm and your ammunition.**

---

**WARNING! Never lock a loaded firearm and never load a locked firearm.**

---

- **Never assume that a “hiding” place is a secure storage method.** Others may be aware of your storage location or come upon it by chance. It is your personal responsibility to use common sense when storing and securing your firearm and ammunition and to always make sure that it is not accessible to children or other unauthorized persons. Always make sure your firearm is unloaded before storing.
- **Always follow the law!!** You must be familiar with all local, state, and federal laws regarding the safe discharge, storage and transportation of your firearm. Failure to know and follow the law may result in unauthorized access or use of your firearm by another. Obey all laws relating to the storage and transportation of firearms. Your local police department or gunshop will furnish you with available information on storing and/or transporting a firearm legally.



## 1.2

## SAFE STORAGE AND TRANSPORTATION

- **Never transport a loaded firearm.** When transporting your firearm, be sure it is unloaded and the cylinder or action is open.
- **Your firearm is your responsibility.** Protect your firearm from theft or misuse by untrained or unqualified individuals.

## 1.3

## PREPARATION FOR FIRING

**WARNING! The failure to follow these firearm safety requirements will cause serious injury or death to you or others.**

- **Always wear adequate and proper ear protection specified for firearm use** to prevent permanent damage to your hearing. Make sure others who are nearby are wearing ear protection as well.
- **Always wear safety glasses specified for firearm use**, whether indoors or out. Safety glasses should protect your eyes from the firing flash and particles associated with the discharge of ammunition. Failure to do so creates a risk of personal injury from particle or debris ejection or ricochets.
- **Never shoot at hard surfaces, water or up into the sky.** Always select a place to shoot that has a safe backstop and is free from obstruction and water surfaces which cause ricochets.
- **Always be aware of people around you** so that persons cannot accidentally walk into the line of fire.
- **Always position the shooter so that all others are out of the line of fire** and are not within an area where they may be struck by ricochets, or by ejected cases.
- **Always keep fingers and other parts of your body away from the muzzle and away from the firearm bolt and ejection port.**
- **Always be alert and always follow the safety instructions of firing range officer.**
- **Always be sure that all actions of firearms are open, that chambers are clear of ammunition, magazines are removed, and the firearm is pointing in a safe direction.**
- **Always be alert.** Never shoot if you are tired, cold or impaired in any way.
- **Always treat your firearm as if it were loaded.**
- **Never use alcohol or drugs before or while shooting.**

**a) General principles**

- There are different types of ammunition for different types of firearms. Your firearm has been designed for ammunition of a specific type and a specific caliber. It is important to select the proper ammunition for your firearm.

---

**WARNING! Never use ammunition not specifically designated for use in your firearm. Failure to use the correct type or caliber of ammunition may cause the firearm to jam, fail to fire or even generate excessive pressure which can damage or even rupture your firearm, causing personal injury, death or property damage.**

---

- You are responsible for selecting ammunition that meets industry standards and is appropriate in type and caliber for this firearm.
- Locate the caliber designation marked on the left side of the upper receiver. This information indicates the ammunition caliber that should be used in this firearm.

**b) Handloaded or reloaded ammunition**

---

**WARNING! Never use non-standard, reloaded or “handloaded” ammunition which has not been subjected to internal ballistic pressure testing. Reloaded or handloaded ammunition may have many manufacturing and quality variables (such as the type and amount of gun powder). Any ammunition that is improperly manufactured, even in the slightest degree, may fail to fire or may generate excessive internal pressures which can damage or even rupture the firearm, causing personal injury or death to the shooter or those in the immediate vicinity.**

---

- Use only commercially manufactured ammunition with internal ballistic pressure which are in strict accordance with the specifications of the Sporting Arms and Ammunition Manufacturers' Institute (SAAMI). If you are uncertain, contact your ammunition supplier for verification.

**b) Ammunition specifications**

- Use only ammunition specifically recommended for your firearm.
- Never mix ammunition.
- Never use a cartridge not specifically designated for use in your firearm.
- Pressure from the wrong type of ammunition may exceed the capability of your firearm and may damage or even rupture your firearm.
- In some cases, a round of ammunition not specified on your firearm may fit into the chamber. Firing ammunition not specified on your firearm may cause it to rupture and cause serious injury or death to you or others.

## 1.4

## AMMUNITION

- Always inspect your ammunition before using it. Never use dirty, corroded or damaged ammunition which can lead to a burst cartridge which may cause damage to the firearm and personal injury or death.

**WARNING!** .22 L.R. caliber cartridges have a wide range of loads, from very weak for sport shooting and maximum precision to very powerful for a high projectile velocity. To ensure reliable operation, a semi-automatic firearm must be matched to a certain cartridge load. For this reason the cal. .22 L.R. HK 416 has been designed for high-quality standard ammunition and HV (High Velocity) ammunition, and one can be sure of trouble-free operation only with these types. Please note that these rifles are not designed for the use of cal. .22 extra long ammunition.

## 1.5

## MANUAL SAFETY

**WARNING!** Always leave the manual safety engaged (on “SAFE”) until you intend to fire.



**Safe Position** Rotate the safety lever counterclockwise so that it points to SAFE.



**Fire Position** rotate the safety lever clockwise so that it points to FIRE.



On the right side of the firearm you also have an indicator for the position of the manual safety.

**WARNING!** Never rely solely on mechanical features alone - always be extremely careful, use safe gun handling practices, and avoid situations which could lead to an accident. Always inspect the chamber of your firearm after the magazine has been removed from the gun. Make sure that no cartridge is left in the chamber.

**WARNING!** Before inspection, make sure that the firearm is always pointed in a safe direction, is ON SAFE, and is unloaded (magazine removed, chamber cleared, empty chamber indicator (red tab) is installed, and barrel clear of any obstructions).

**WARNING!** Never put your hand in front of the muzzle.

### Functional Inspection

1. Bolt movement: Remove the magazine and retract the bolt by pulling back the charging handle. Release the charging handle to return the bolt fully forward into battery.
2. Bolt catch: Insert the empty magazine, retract the bolt by pulling back the charging handle. The bolt locks back in rearmost position.
3. Decocking: Make sure that the firearm is ON SAFE and unloaded (magazine removed, chamber cleared, empty chamber indicator (red tab) is installed, and barrel clear of any obstructions)!

Pull charging handle rearward and then release allowing it to freely move forward. Place safety in the "FIRE" position, make sure the muzzle is pointed in a safe direction. Pull the trigger. The hammer drops to a de-cocked position. Put back on "SAFE".

**WARNING!** Before loading, make sure that the firearm is always pointed in a safe direction, is ON SAFE, and is unloaded (magazine removed, chamber cleared, empty chamber indicator (Red tab) is installed, and barrel clear of any obstructions).



Press magazine release and remove empty magazine.

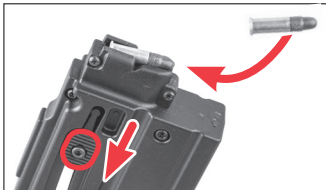

Use the side-mounted button to push the follower down. Insert the cartridge under the magazine lips, pushing down the follower. Do not use excessive force.

## 2.2

## LOADING THE FIREARM



Insert the loaded magazine until the magazine catch locks it in position (fig. 7). After inserting a magazine, always test to make sure it is locked in place by giving it a firm tap on the bottom of the magazine.

## 2.3 LOADING THE CHAMBER WITH THE FIRST CARTRIDGE

**WARNING! Never put your hand in front of the muzzle.**

**WARNING! Always load a round into the chamber by feeding it from the magazine. Failure to follow this warning can result in severe injury or death to you or others. Never attempt to load the firearm by inserting a round into the open ejection port.**



Pick up the firearm with your shooting hand and point the muzzle in a safe direction. Use your other hand to retract and release the bolt with the help of the charging handle. Never put your hand in front of the muzzle. As the bolt travels forward, it inserts the first round into the chamber. The hammer is now cocked. Leave the safety in the safe position until you are ready to fire.



## 2.3 LOADING THE CHAMBER WITH THE FIRST CARTRIDGE

**WARNING!** HK 416 cal. .22L.R. are designed so that they are able to fire when the magazine is removed. Therefore, if the magazine is removed from the firearm and there is a loaded round in the chamber, it will fire if the trigger is pulled. After inserting a magazine, always test to make sure it is locked in place by applying some removal pressure to the magazine.

**WARNING!** Your firearm is now ready to fire. Keep your finger off the trigger and out of the trigger guard until you are ready to fire.

## 2.4 FIRING

Grasp firearm with one hand on forearm and other hand on grip with index finger resting along outside of trigger guard. Raise firearm and pull buttstock firmly into shoulder. Aim at a safe target. Push the manual safety to the fire position. Squeeze the trigger slowly and maintain the pressure until the round is fired. Your firearm loads another round immediately after firing.



- You may continue to fire by pulling and fully releasing the trigger until the magazine is empty.
- If you wish to stop, release trigger, remove finger from trigger guard, and set safety selector to “SAFE” position.
- If you have fired the last round from the magazine, the bolt will be held in the rearmost position so that the firearm can quickly be reloaded by replacing the magazine, or the chamber can be inspected to ensure it is empty.

**WARNING! Keep the firearm pointed in a safe direction when decocking.**  
**Failure to do this can result in serious injury or death.**

- If you decide not to fire after the hammer has been cocked or if you decide to suspend firing, keep the firearm pointed in a safe direction.
- Remove your finger from within the trigger guard.
- Place the manual safety in the “SAFE” position and remove the magazine.
- Pull charging handle rearward to eject any remaining cartridge(s).
- Make sure that the firearm is unloaded (magazine removed, chamber cleared, empty chamber indicator (RED TAB) installed, and barrel clear of any obstructions)!
- You must be certain there is no cartridge in the chamber or obstructions in the barrel. Remember that any time you release the bolt while a magazine containing cartridges is in the firearm, you will have reloaded the firearm and it will be capable of firing.
- Place the manual safety in the “FIRE” position.
- Squeeze trigger to decock the firearm.
- The firearm may now be transported safely.

**NOTE: The external bolt catch lever is without function. The gun has an internal bolt catch. To put the bolt into its forward position, first insert the simulating device (RED TAB), then retract the charging handle and release it.**



## 2.6

## FIREARM WITH EMPTY MAGAZINE

**NOTE:** After the last round has been fired, the bolt catch holds the bolt in the open position. Place the manual safety in the “SAFE” position.



### Continue shooting

Replace the empty magazine with a full one. Pull bolt rearward and release with the help of the charging handle, the bolt will travel forward and load the chamber with the first round. Keep your firearm in your shooting hand, finger off the trigger and the firearm pointed in a safe direction so that there is no danger to you or other persons.

### Discontinue shooting

Remove magazine and inspect the chamber to verify it does not contain any ammunition. Close the bolt and decock hammer as described in section 6.

## 2.4

## UNLOADING

Point the muzzle in a safe direction. Make sure the firearm in ON SAFE. Remove the magazine. Ensure that the chamber is empty by pulling back the charging handle to visually inspect the chamber (fig. 9). Place empty chamber indicator (Red tab) into the empty chamber (fig. 23). Keep firearm pointed in a safe direction. Retract the charging handle so that the bolt moves into battery. Push the manual safety to the “FIRE” position (fig. 10) and squeeze trigger to decock the firearm. The firearm may now be carried safely.



**WARNING!** If your firearm gives any indication that it is not performing properly or the operation of your firearm has changed “the way it feels or sounds”, stop firing. Make sure the firearm is pointed in a safe direction, unload the firearm and have it inspected and test fired by an HECKLER & KOCH qualified gunsmith.

- If a cartridge fails to fire, wait 30 seconds while keeping the muzzle pointed in a safe direction.
- Keep your finger off the trigger and out of the trigger guard.
- Place the manual safety in the “SAFE” position and remove the magazine.
- Grasp the bolt with the charging handle and briskly pull it fully rearward to eject the misfired round. Check the barrel chamber and bore visually for any obstructions. Never look down the barrel from the muzzle end.
- You must be certain there are no cartridges in the chamber or obstructions in the barrel. Remember that any time you release the bolt while a magazine containing cartridges is in the firearm, you will have reloaded the firearm and it will be capable of firing.

**NOTE:** The forward assist plunger is without function. In case of feeding failures, retract the charging handle to extract the damaged round.

**WARNING!** Never try to use a misfired cartridge again.

### 3.1

### SETTINGS - SIGHTS

The dual aperture rear sight can be adjusted for two different diopter diameters by flipping the smaller aperture up or down.



#### Normal range

The smaller aperture is used for > 50 yards (50 meters) range.



#### Short range

The larger aperture is used for 0 - 50 yards (0-50 meters) range.

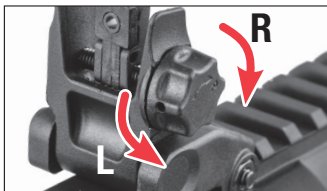
**3.1****SETTINGS - SIGHTS****Windage adjustment (rear sight)**

The windage is adjusted using the windage knob on the side of the rear sight. Turning the knob adjusts for windage left or right. Amount of adjustment is defined by a click when the knob is turned.

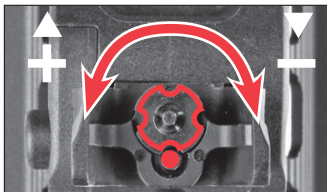
**Elevation adjustment (front sight)**

The elevation is adjusted by pushing in the front sight post detent (●) near the front sight post and simultaneously turning the front sight post in desired position. The front sight post must be engaged in one of the four detents.

**3.2****SETTINGS - STOCK (HK416D ONLY)****Setting of the retractable stock**

The length of the buttstock can be adjusted. Pushing the buttstock latch allows the buttstock to be adjusted to various lengths.

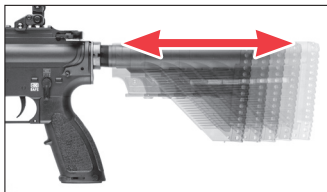

### Setting of the bolt speed

The bolt speed can be adjusted for different ammunition requirements. To reach the screw for bolt speed adjustment the gun has to be disassembled as described in chapter „Field Stripping“. Only adjust the bolt speed if problems are encountered when firing a different type of ammunition.

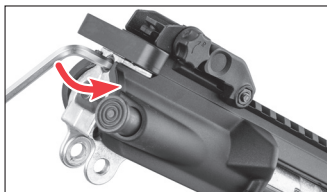

**For standard ammunition**, use the correct size hex key to decrease the bolt speed by turning the screw counterclockwise.

---

**NOTE: The screw head must not rise out or be removed from the gun.**

---

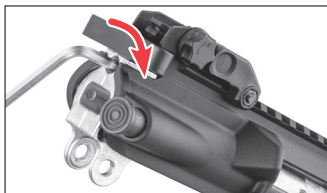

**For high velocity ammunition**, use the correct size hex key to increase the bolt speed by turning the screw clockwise.

### Mounting an optical sight



**To mount an optical sight**, the rear sight can be removed by loosening the screw on the left side of the rear sight. This will provide a mil-standard rail for mounting of optics.

## Using the Pistol Grip Compartment Storage

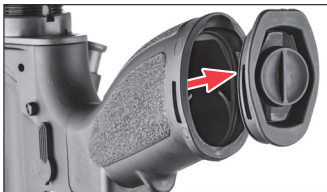

The grip contains a compartment storage. Turn the pistol grip button counterclockwise and pull the pistol grip cap out of the grip. Close the storage in reverse order until the pistol grip cap locks in.

**WARNING!** Always follow the disassembly instructions exactly. Never do anything beyond what you are specifically instructed to do in this manual. Never Alter or modify the parts in your firearm. Always wear eye protection that is specified for use with firearms, every time you handle your firearm for cleaning and maintenance. Prior to disassembly, place the manual safety in the safe position, take out the magazine and check that the firearm is not loaded.



To disassemble insert an empty magazine, pull back the bolt to its rearmost position with the charging handle. Remove the magazine for further disassembly. Push the rear receiver pin out of the gun to the right. Do not use excessive force.

**NOTE: Further disassembly is not necessary or recommended and will void your warranty.**

In order to keep the firearm functional and to extend its service life, the firearm should be cleaned and maintained at regular intervals.

**WARNING! Before cleaning, make sure that the firearm is always pointed in a safe direction, is ON SAFE, and is unloaded (magazine removed, chamber cleared, empty chamber indicator (Red tab) is installed, and barrel clear of any obstructions).**

Remove fouling from breech, magazine lips, follower, and receiver with a brush and a cloth. Clean the barrel with bore solvent and a brush and then dry it with cleaning patches; always begin at the chamber. Repeat until barrel is clean. Apply a thin coat of oil to all metal parts. Reassemble firearm and check for proper function.

- Verify gun is ON SAFE.
- Insert EMPTY magazine and retract charging handle so that bolt assembly remains in open position.
- Remove magazine.
- Visually inspect to verify that no ammo remains anywhere in the rifle.
- Remove rear receiver pin so that upper receiver pivots upward
- Thoroughly clean the bolt assembly area with a brush and cloth (aerosol gun scrubber works great) to remove powder residue and debris.
- Clean the barrel with bore solvent utilizing a flexible cleaning rod inserted through breech end of barrel (where bullet seats).

**NOTE: Cleaning the barrel from the muzzle end requires a bore brush that does NOT exceed 1-inch in the length. Using a brush exceeding this length will result in the brush being lodged in the breech area.**

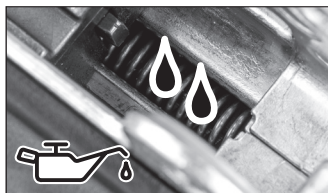

- Apply 2 drops of gun oil to the main spring.
- Apply 1 drop of gun oil to the extractor.



## 5.2

## MAINTENANCE



- Apply 1 drop of gun oil to each end of firing pin assembly.

---

**NOTE: Do not apply more oil to the recoil spring, extractor or firing pin assembly than is mentioned above. Doing so will result in an increased accumulation of powder residue which can lead to misfires and jamming issues.**

---

- Reassemble rifle by installing the rear pin. Make sure it is in correct position.
- Wipe down exterior surface of rifle with gun oil.
- Insert the RED TAB (empty chamber indicator), pull the charging handle rearward, then release to close the bolt assembly.

## 5.3

## STORAGE

---

**WARNING! Never leave a loaded firearm unattended!**

---

Always keep and store your firearm in an unloaded condition with the safety in the “SAFE” position. Keep the firearm and ammunition away from children and unauthorized persons. Firearms should be stored separately from ammunition. Always store your firearm with the empty chamber indicator (RED TAB) in the chamber to make sure no cartridge is loaded.



Do not return defective or damaged product to the dealer. If your firearm needs repair, call HK Customer Service Department at 706-568-1906.

Common causes of problems that are often overlooked include:

- Fouled or improperly lubricated pistol
- Bad ammunition
- Damaged magazines
- Operator error

If your rifle / pistol still fails to function, please contact HK Customer Service Department at 706-568-1906 for the name and address of your nearest HK Authorized Repair Facility. Law enforcement users, contact your unit armorer or HK Customer Service Department.

---

**WARNING! Only an authorized and qualified HECKLER & KOCH gunsmith should inspect and repair your firearm!**

---

### **Limited one year warranty**

This product is warranted to the original owner for 1 year from date of purchase against defects in material and workmanship and is not transferable.

#### **What is covered**

Replacement parts and labor.

#### **What is not covered**

Parts, labor, and shipping charges to HECKLER & KOCH for defective product and damages caused by abuse or failure to perform normal maintenance as well as any other expense. Consequential damages, or incidental expenses, including damage to property. HECKLER & KOCH will not be responsible for unauthorized adjustments or modifications, use of defective or improper ammunition, corrosion, criminal misuse, negligence, resale, and/or use under the influence of drugs or alcohol. Some states do not allow the exclusion or limitation of incidental or consequential damages, so the above limitation or exclusion may not apply to you. HECKLER & KOCH reserves the right to determine what constitutes ordinary wear and tear.

#### **Warranty claims**

Warranty Claims and Repair for U.S. customers. Call HECKLER & KOCH and ask for the Customer Service Department. If it is determined a return is necessary, you will be issued a Return Authorization Number. Write this number boldly on the box and return the product prepaid to HECKLER & KOCH. Your name, address, phone number and a note with the model number, serial number, and explanation of the defect found must be included in the package. A copy of the original purchase receipt must accompany the return.

### Implied warranties

Any implied warranties, including the implied warranties of merchantability and fitness for a particular purpose, are limited in duration to 1 year from date of retail purchase. Some states do not allow limitations on how long an implied warranty lasts, so the above limitations may not apply to you. To the extent any provision of this warranty is prohibited by federal state, or municipal law which cannot be preempted, it shall not be applicable. This warranty gives you specific legal rights, and you may also have other rights which vary from state to state and country to country.

Under no circumstances shall HECKLER & KOCH be responsible for incidental or consequential damages with respect to economic loss, injury, death or property damage, whether as a result of breach of this warranty, negligence or otherwise.

---

**Note: all liability is excluded in the event that the instructions and warnings in this manual are not observed.**

---

### Shipping guidelines

- Ensure that the firearm is unloaded.
- Do not attempt to ship a firearm via us postal service; only federally licensed firearm dealers may ship a firearm by us postal service.
- Do not ship any ammunition.
- Enclose a letter which includes your full name and address (no P.O. Boxes, please), daytime telephone number, e-mail address, the serial number of the firearm, and details of the problem experienced (stating the brand and type of ammunition used when the problem occurred) or work desired.
- Record the serial number before shipping, in case you wish to check on the repair status of your firearm.
- Please remove all custom parts and accessories, such as stocks, special sights and scopes, or slings from your firearm before returning.
- Place the firearm in its original case or in a similarly secure container and pack it securely.
- The package must not bear any markings which indicate the identity of the contents.
- It is recommended that shipments be insured by the owner, since HECKLER & KOCH will accept no responsibility for loss or damage in transit.
- It is most important that you comply with federal, state, and local laws and regulations. The following guidelines are meant to help, but you must seek assistance from the appropriate authorities if necessary.
- If your firearm must be replaced, it may be necessary to ship the replacement to a dealer rather than directly to you. You will be requested to furnish a signed FFL (Federal Fire arms License) from your dealer in such an instance.



**6.1****TECHNICAL DATA**

	<b>HK416 .22 RIFLE</b>	<b>HK416 .22 PISTOL</b>
caliber	.22 L.R. HV	.22 L.R. HV
action	blowback	blowback
trigger	single stage trigger	single stage trigger
trigger pull	6.6 - 12.1 lbs (3500 - 5500 g)	6.6 - 12.1 lbs (3500 - 5500g)
magazine capacity	10, 20, 30 rounds	10, 20, 30 rounds
dimensions (L/H/W)	38 / 10.8 / 2.6 inch (965 / 275 / 65 mm)	16.7 / 10.7 / 2.5 inch (425 / 272 / 63.8 mm)
barrel length	16.1 inch (409 mm)	8.5 inch (217 mm)
sight radius	14 inch (354.6 mm)	12 inch (304.6 mm)
height / width	1.3 / 2.1 inch	1.3 / 2.1 inch
of rear sight aperture	(33 / 54.2 mm)	(33 / 54.2 mm)
front sight width	0.07 inch (1.8 mm)	0.07 inch (1.8 mm)
weight w/out mag	5.7 lbs (2580 g)	4.5 lbs (2050 g)
magazine weight (empty)	6.8 ounce (190 g)	6.8 ounce (190 g)

**6.2****VARIANTS****HK416 .22 RIFLE**

- Aluminum Receivers
- RIS–Rail Interface System M-LOK®
  - / Mil STD. 1913
  - Retractable Stock
- Pistol Grip with Compartment store
  - Adjustable Flip up sights
    - 90° Manual Safety
  - Functional Dust Cover

**HK416 .22 PISTOL**

- Aluminum Receivers
- RIS–Rail Interface System M-LOK®
  - / Mil STD. 1913
- Pistol Grip with Compartment store
  - Adjustable Flip up sights
    - 90° Manual Safety
  - Functional Dust Cover

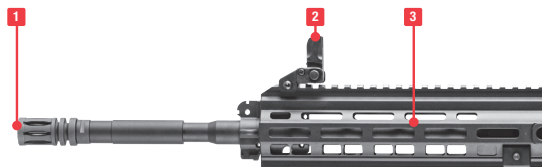

- 1** Muzzle
- 2** Front sight
- 3** Rail system

- 4** Upper receiver
- 5** Lower receiver
- 6** Trigger guard

- 7** Rear sight
- 8** Safety
- 9** Charging handle

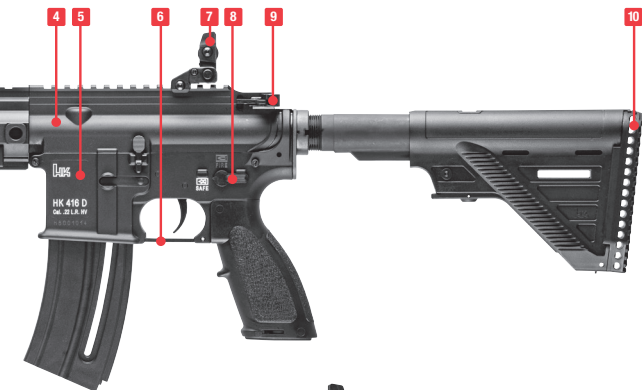

- 10** Buttpad
- 11** Buttstock
- 12** Grip

- 13** Rear receiver pin
- 14** Trigger
- 15** Magazine release

- 16** Ejection port cover
- 17** Magazine
- 18** Flash suppressor











**HECKLER & KOCH**

**HECKLER & KOCH**  
Sales + Warranty Service  
5675 Transport Blvd. Columbus, GA 31907

[www.hk-usa.com](http://www.hk-usa.com)